



YUN 云锦电器

余姚市云锦电器有限公司

Yuyao Yunjin Electrical Appliance Co., Ltd

电话(Tel): 0574-62160980

手机(Mob): 18072038796

传真(Fax): 0574-62100790

邮箱(E-mail): 1390204519@qq.com

网址(Web): www.yyunjin.com

地址: 中国浙江余姚市泗门镇共济路5号

Address: No.5 Gongji Road, Simen Town, Yuyao Zhejiang, 315470

YUN 云锦电器

YUNJIN ELECTRICAL

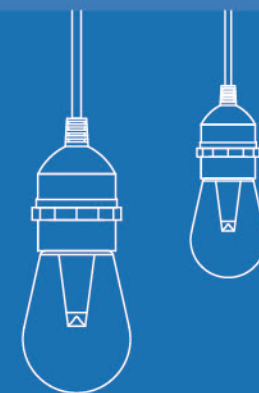

智能灯串
smart string lights

余姚市云锦电器有限公司

Yuyao Yunjin Electrical Appliance Co., Ltd



企业简介

余姚市云锦电器有限公司是一家集生产、研发和销售于一体的高新技术企业，公司地址位于浙江余姚市泗门镇工业园区，北靠上海，西临杭州，交通十分便利，占地面积18000m²，研发人员20余人，企业员工300余人，本公司主营各国户外LED防水灯串、低压灯串、智能灯串、调光灯串、太阳能灯串、庭院地插串灯、草坪灯、射灯、灯头灯座、汽车线束、汽车取电器、各国电源线、插头座、连接线等，拥有多项实用型专利，并取得 C(ETL)US, FCC, CE, SAA, PSE, KEMA-KEUR, CB, IP65, ROHS, CPSIA, CP65等配套测试报告及认证证书。公司拥有完整、科学的ISO9001-2015质量管理体系，BSCI认证企业商业管理规范，具备先进的生产设备，多条生产流水线，全套检验设备，以严谨的工作态度，创新的科学意识，过硬的产品质量，赢得了广大客户的认可。产品销售网络遍布全球，远销欧洲、北美、澳洲、中东、南非等二十多个国家和地区。公司秉承合作共赢的文化理念、崇尚诚信立业服务客户的经营宗旨，立足品质优良创新制胜的发展思路，诚信、实力和产品质量获得业界的认可。欢迎各界朋友莅临参观、指导和业务洽谈。愿我们携手合作，共创未来。

Yunjin Electrical Introduction

Yuyao Yunjin Electrical Appliance Co., Ltd. is a company integrating research, development, manufacture and sales of high-tech enterprise. The company's address is located in industrial park of Simen Town, Yuyao City, Zhejiang Province. It is close to Shanghai in the north, Hangzhou in the west, and Ningbo in the south. The transportation is very convenient. Covering an area of 18000M², there are more than 20 research and development personnel and more than 300 enterprise employees. The main products of Yunjin are outdoor LED waterproof string lights, low-voltage string lights, smart string lights, dimming string lights, solar string lights, courtyard string lights, pathway lights, spot lights, lamp holders, car wiring harnesses, and car Electrical appliances, power cords, plug sockets, connecting cables, etc, and has a number of practical patents, and obtained C(ETL)US, FCC, CE, SAA, PSE, KEMA-KEUR, CB, IP65, ROHS, CPSIA, CP65 and other matched test reports and certificates. The company has a complete ISO9001-2015 and BSCI audited management standards. Yunjin has advanced production equipment, multiple production lines, a complete set of inspection equipment, rigorous work attitude, innovative scientific awareness, and excellent products. Insisting quality has won high recognition from customers. The product sales network is all over the world, and exported to more than 20 countries and regions such as Europe, North America, Australia, the Middle East, and South Africa. The company adheres to the cultural concept of win-win cooperation, advocates the business tenet of establishing a business with integrity and serving customers, and is based on the development idea of high-quality innovation and winning, and its integrity, strength and product quality have been recognized by the industry. Welcome you, and hope we'll work together to create a better future.





OUR
EQUIPMENT AND FACILITIES
设备设施



重信用、守合同

余姚市云锦电器有限公司实力雄厚，重信用、守合同、保证产品质量，良好的品质和准时交货是企业赖以生存和发展的生命线，全公司上下将以更好的质量，更准时的交货日期来回报广大客户的信赖与支持，我们将一如既往的坚持使命：专业铸造品质，专注特殊线材生产。以多品种经营特色和薄利多销的原则，赢得了广大客户的信任。

Abide by promises and contracts

Yuyao Yunjin Electrical Appliance Co., Ltd. has strong strength, pays attention to credit, abides by the contract and ensures product quality. Good quality and on-time delivery are the lifeline for the survival and development of the enterprise. The whole company will repay the trust and support of our customers with better quality and more punctual delivery date. We will always adhere to our mission: professional casting quality and focus on special wire rod production. It has won the trust of our customers with the principle of multi variety management characteristics and small profit and quick turnover.

ABIDE BY PROMISES
AND CONTRACTS

THE CONTENT

01	智能灯串 Intelligent light string	P01-54
	澳规智能灯串 Australian smart string lights	P02-07
	欧规智能灯串 European smart string lights	P07-09
	美规高压灯串 American high voltage lamp string	P10-16
	太阳能灯串 Solar String Light	P17-18
	草坪灯系列 Lawn lamp series	P17-21
	其它灯串 Other light strings	P22-25
	灯泡 Light bulb	P26
	灯头系列 Lampholder Series	P27-33
	连接公母头系列 Male and female head connection series	P34-38
	三通连接系列 Branch connector series	P39-42
	适配器系列 Power unit series	P43-49
	取电线 Take wire	P50-54
02	插头系列 Plug series	P55-88
	美国标准插头座系列 Plugs to the American Standard	P55-63
	欧洲标准插头系列 Plugs to the European standard	P64-67
	IEC连接器系列 IEC Connector Series	P68-70
	日本标准插头系列 Plugs to the Japanese Standard	P71-74
	丹麦标准插头系列 Plugs to the Danish Standard	P74
	韩国标准插头系列 Plugs to the Korea Standard	P73-74
	中国标准插头系列 Plugs to the Chinese Standard	P75-79
	澳大利亚标准插头系列 Plugs to the Australian Standard	P80-81
	南非标准插头系列 Plugs to the South Afic Standard	P82
	阿根廷标准插头系列 Plugs to the Argentina Standard	P83-84
	意大利标准插头系列 Plugs to the Italy Standard	P83-84
	瑞士标准插头系列 Plugs to the Switzerl Standard	P85-86
	英国标准插头系列 Plugs to the British Standard	P85-86
	以色列标准插头系列 Plugs to the Israel Standard	P87-88
	巴西标准插头系列 Plugs to the Brazil Standard	P87-88
03	线缆技术资料 Electron technical information	P89-100

Remote Control via App

Free your hands with smart lighting

- Power ON/OFF
- 2.4GHz Wi-Fi Only
- Adjust Brightness
- Change Colors
- Switch Scenes
- Schedule Setting

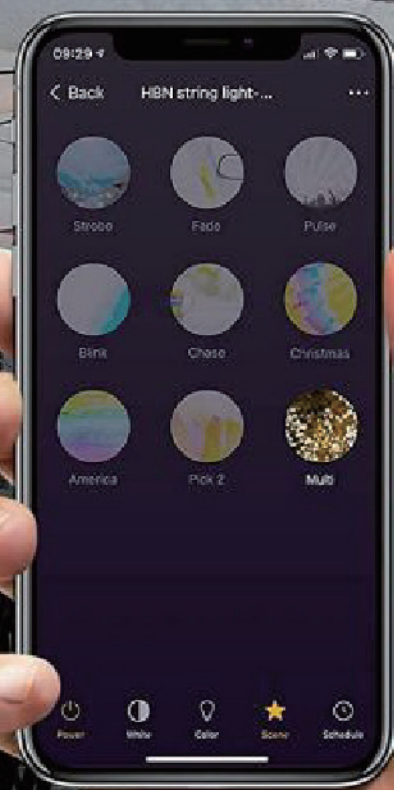

澳规智能白灯灯串

YJ-2, YJ-SW15A, YJ-SW15AO, YJ-SW15E, YJ-SW15EO



- 1.Ratings:100~240V, 50/60Hz, 12Vdc, 36W, ClassIII, IP65, ta25°C
- 2.Plug/Couple connector:FS-3D(A2-10)/ GMT-2
- 3.The Supply Cord:H05VV-F 2X1.0mm²/ H05RN-F 2X1.0mm²
- 4.The String Light Cord:H05VV-F 2X0.75mm²/ 21996 2/C 20AWG/ H05RN-F 2X0.75mm²

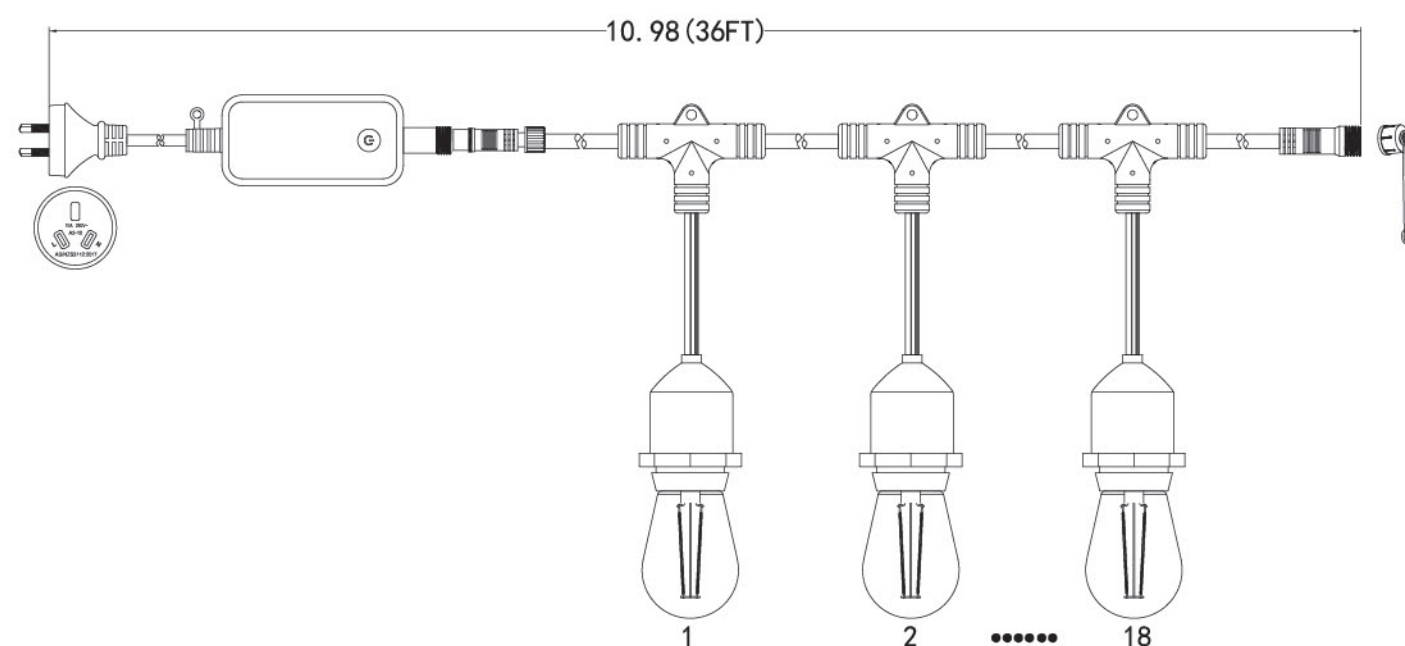

澳规智能彩灯灯串

YJ-3, YJ-312, YJ-SC15A, YJ-SC15AO, YJ-SC15E, YJ-SC15EO



- 1.Ratings:100~240V, 50/60Hz, 12Vdc, 24W, ClassIII, IP65, ta25°C
- 2.Plug/Couple connector:FS-3D(A2-10)/GMT-3
- 3.The Supply Cord:H05VV-F 2X1.0mm²/ H05RN-F 2X1.0mm²
- 4.The String Light Cord:H05VV-F 3X0.75mm²/ 21996 3/C 20AWG/ H05RN-F 3X0.75mm²

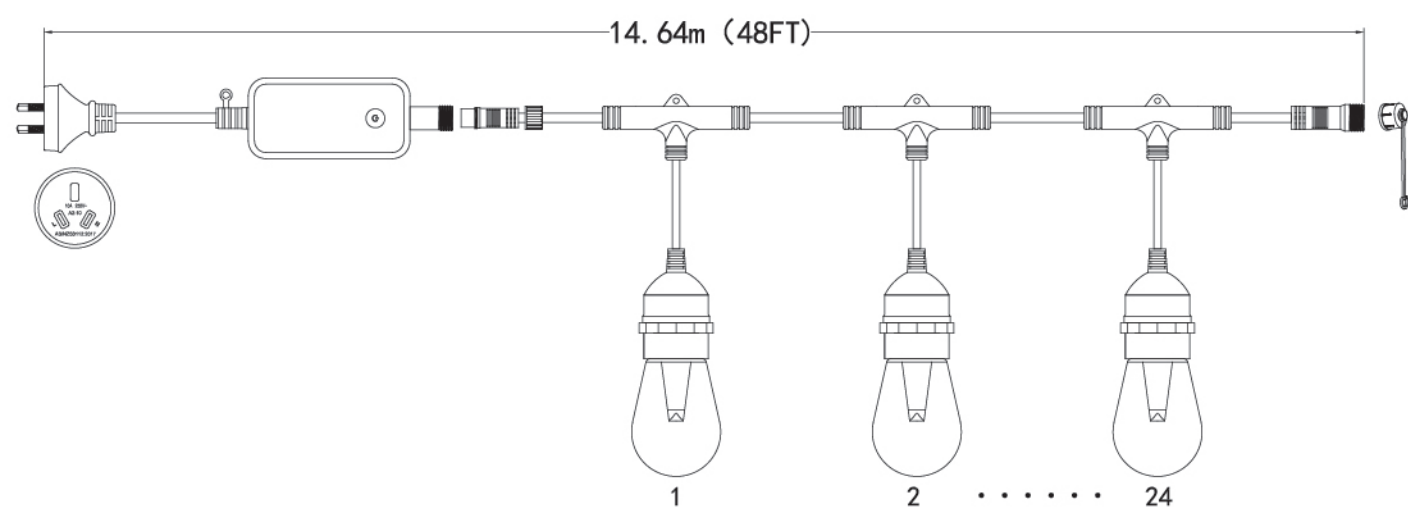

澳规智能彩灯灯串

YJ1450



- 1.Ratings:100~240V~, 50/60Hz, 12VDC, 24W
- 2.Plug/Couple connector:A2-10/GMT-3
- 3.The Supply Cord:H05RN-F 2X1.0mm²
- 4.The String Light Cord:21996 3/C 22AWG

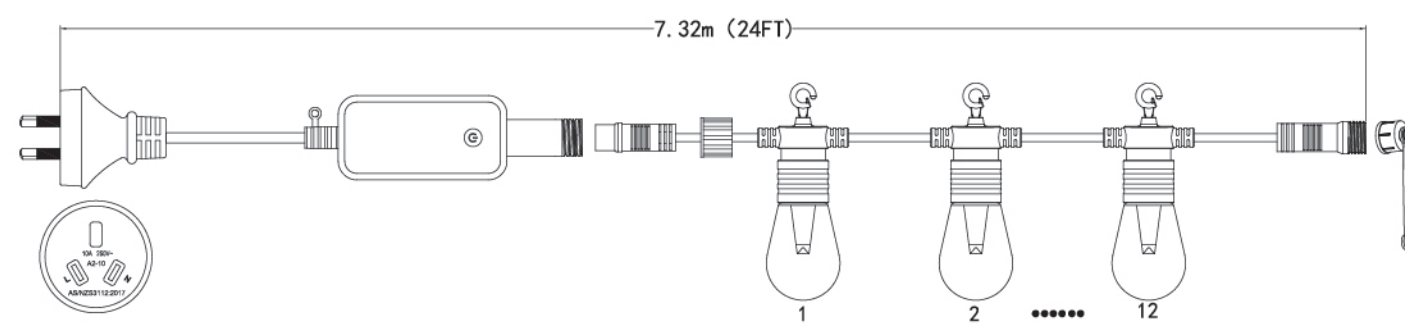
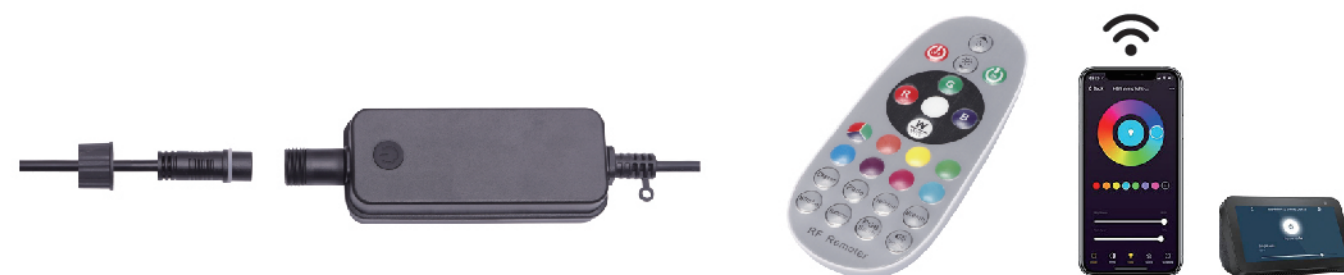

澳规智能白灯灯串

YJ-2,YJ-SW15A,YJ-SW15AO,YJ-SW15E,YJ-SW15EO



- 1.Ratings:100~240V~, 50/60Hz. 12Vdc,36W, ClassIII,IP65,ta25°C
- 2.Plug/Couple connector:FS-3D(A2-10)/ GMT-2.
- 3.The Supply Cord:H05VV-F 2X1.0mm²/ H05RN-F 2X1.0mm²
- 4.The String Light Cord:H05VV-F 2X0.75mm²/ 21996 2/C 20AWG

澳规智能彩灯灯串

YJ1450



- 1.Ratings:100~240V~, 50/60Hz. 12VDC, 24W, ClassIII, IP65, ta25°C
- 2.Plug/Couple connector:FS-3D(A2-10)/GMT-3.
- 3.The Supply Cord:H05RN-F 2X1.0mm²
- 4.The String Light Cord:21996 3/C 22AWG

澳规智能彩灯灯串 (钻石亚克力泡壳)

YJ-3,YJ-312,YJ-SC15A,YJ-SC15AO,YJ-SC15E,YJ-SC15EO



- 1.Ratings:100~240V~, 50/60Hz. 12Vdc,24W, ClassIII,IP65,ta25°C
- 2.Plug/Couple connector:FS-3D (A2-10)/ GMT-3.
- 3.The Supply Cord:H05VV-F 2X1.0mm²/ H05RN-F 2X1.0mm²
- 4.The String Light Cord:H05VV-F 3X0.75mm²/ 21996 3/C 20AWG

澳规智能彩灯灯串 (S14 PC泡壳)

YJ-3,YJ-312,YJ-SC15A,YJ-SC15AO,YJ-SC15E,YJ-SC15EO



- 1.Ratings:100~240V~, 50/60Hz. 12Vdc,24W, ClassIII,IP65,ta25°C
- 2.Plug/Couple connector:FS-3D(A2-10)/GMT-3.
- 3.The Supply Cord:H05VV-F 2X1.0mm²/ H05RN-F 2X1.0mm²
- 4.The String Light Cord:H05VV-F 3X0.75mm²/ 21996 3/C 20AWG

澳规智能彩灯灯串

AT1450



- 1.Ratings:100~240V~, 50/60Hz. 12VDC,24W, ClassIII,IP65,ta25°C
- 2.Plug/Couple connector:FS-3D(A2-10)/GMT-3.
- 3.The Supply Cord:H05RN-F 2X1.0mm²
- 4.The String Light Cord:21996 3/C 22AWG



欧规智能白灯灯串

AT1450



- 1.Ratings:170~250V~, 50/60Hz, 12VDC, 24W
- 2.Plug/Couple connector:GMT-2/ YJ002-F
- 3.The Supply Cord:H05RN-F 2X1.0mm²
- 4.The String Light Cord:21996 2/C 22AWG



欧规智能白灯灯串

YJ-2, YJ-SW15A, YJ-SW15AO, YJ-SW15E, YJ-SW15EO



- 1.Ratings:100~240V, 50/60Hz. 12Vdc, 36W, ClassIII, IP65, ta25°C
- 2.Plug/Couple connector:YJ002-F(JT002-F)/GMT-2
- 3.Cord:H05VV-F 2X1.0mm²/H05RR-F 2X1.0mm²/ H05RN-F 2X1.0mm²/ H07RN-F 2X1.0mm²



欧规智能彩灯灯串

YJ-3, YJ-312, YJ-SC15A, YJ-SC15AO, YJ-SC15E, YJ-SC15EO



- 1.Ratings:100~240V, 50/60Hz. 12Vdc, 24W, ClassIII, IP65, ta25°C
- 2.Plug/Couple connector:YJ002-F(JT002-F)/GMT-3.
- 3.The Supply Cord:H05VV-F 2X1.0mm²/ H05RR-F 2X1.0mm²/ H05RN-F 2X1.0mm²/ H07RN-F 2X1.0mm²
- 4.The String Light Cord:H05VV-F 3X1.0mm / H05RR-F 3X1.0mm²/ H05RN-F 3X1.0mm²/ H07RN-F 3X1.0mm²/ 21996 3/C 20AWG



欧规智能彩灯灯串

YJ1450



- 1.Ratings:170~250V~, 50/60Hz. 12VDC, 24W
- 2.Plug/Couple connector:GMT-3/ YJ002-F.
- 3.The Supply Cord:H05RN-F 2X1.0mm²
- 4.The String Light Cord:21996 3/C 22AWG



YUN 云锦电器

美规高压灯串

American high voltage lamp string

欧规智能彩灯灯串

YJ1452



- 1.Ratings:100~240V,50/60Hz, 12VDC,24W
ClasIII,IP44 ta25°C
- 2.Cord:2x0.3mm²
- 3.G50 LED Bulbs

美规高压二芯灯串

YJE26-16XXXYY, YJE26-14XXXYY



- 1.Ratings:120V, 60Hz.Maximum rating, in watts, of E26 lamp, max. 25W
- 2.Plug/Receptacle:YJ-2/YJ-2Z
- 3.The suffix letters "XXX" denote the cord length.
- 4.The suffix letters "YY" denote the No. of lampholders and lamps provided, min. 2 pcs, max
- 5.SJTW 2/C16AWG = max. 1200 Watts total for string light
- 6.SJTW 2/C14AWG = max. 1440 Watts total for string light
- 7.Name for example:YJE26-1602412, YJE26-1402412

美规高压二芯灯串 (带保险丝8A或5A)

YJE26-18XXXYY



- 1.Ratings:120V, 60Hz.Maximum rating, in watts, of E26 lamp, max. 25W
- 2.Plug/Receptacle:JT-2FC/JT-2ZF
- 3.The suffix letters "XXX" denote the cord length
- 4.The suffix letters "YY" denote the No. of lampholders and lamps provided, min. 2 pcs, max
- 5.SJTW 2/C18AWG = max. 960 Watts total for string light with 8A fuse
- 6.SJTW 2/C18AWG = max. 432 Watts total for string light with 5A fuse
- 7.Name for example:YJE26-1802412

美规高压三芯灯串 (带保险丝8A或5A)

YJE26-18XXXYY



- 1.Ratings:120V, 60Hz.Maximum rating, in watts, of E26 lamp, max. 25W
- 2.Plug/Receptacle:YJ-3F/YJ-3Z
- 3.The suffix letters "XXX" denote the cord length
- 4.The suffix letters "YY" denote the No. of lampholders and lamps provided, min. 2 pcs, max
- 5.SJTW 3/C18AWG = max. 960 Watts total for string light with 8A fuse
- 6.SJTW 3/C18AWG = max. 432 Watts total for string light with 5A fuse
- 7.Name for example:YJE26-1802412

美规高压三芯灯串

YJE26-16XXXYY, YJE26-14XXXYY



- 1.Ratings:120V, 60Hz.Maximum rating, in watts, of E26 lamp, max. 25W.
- 2.Plug/Receptacle:YJ-3/YJ-3Z.
- 3.The suffix letters "XXX" denote the cord length.
- 4.The suffix letters "YY" denote the No. of lampholders and lamps provided, min. 2 pcs, max.
- 5.SJTW 3/C16AWG = max. 1200 Watts total for string light.
- 6.SJTW 3/C14AWG = max. 1440 Watts total for string light
- 7.Name for example:YJE26-1602412, YJE26-1402412

美规高压二芯灯串 (带保险丝8A或5A)

JHE26-18XXXYY



- 1.Ratings:120V, 60Hz.Maximum rating, in watts, of E26 lamp, max. 25W.
- 2.Plug/Receptacle:JT-2FC/JT-2ZF.
- 3.The suffix letters "XXX" denote the cord length.
- 4.The suffix letters "YY" denote the No. of lampholders and lamps provided, min. 2 pcs, max.
- 5.SJTW 2/C18AWG = max. 960 Watts total for string light with 8A fuse
- 6.SJTW 2/C18AWG = max. 432 Watts total for string light with 5A fuse
- 7.Name for example:JHE26-1802412

美规智能白灯灯串 (带保险丝5A)

YJ-2-XX, YJ-SW15A, YJ-SW15AO, AT1327, YJ-SW30A, LBS900-XX



- 1.Ratings:120V, 60Hz. Max. interconnected:36W.
- 2.Plug/Couple connector:YJ-2F/SP02-1/SP02-2.
- 3.The suffix "followed by up to two characters" denoted the number of LED bulbs, min. 2pcs. YJ-SW15A-15LED bulbs, YJ-SW15AO-15LEDbulbs, YJ-SW30A-30LED bulbs, AT1327-18LED bulbs,
- 4.The main line:SJTW 2/C 18AWG and 21996 2/C 20AWG
- 5.The bulb type:PC S14

美规智能彩灯灯串 (带保险丝5A)

YJ-312-XX, YJ-SC15A, YJ-SC15AO, YJ-SC30A, LBS800-XX



- 1.Ratings:120V, 60Hz. Max. interconnected:24W
- 2.Plug/Couple connector:YJ-2F/SP03-1/SP03-2
- 3.The suffix "followed by up to two characters" denoted the number of LED bulbs, min. 2pcs YJ-SC15A-15LED bulbs, YJ-SC15AO-15LED bulbs, YJ-SC30A-30LED bulbs
- 4.The main line:SJTW 2/C 18AWG and 21996 3/C 20AWG
- 5.The bulb type:PC S14

美规智能彩灯灯串 (带保险丝5A)

YJ-312-XX YJ-SC15A YJ-SC15AO, YJ-SC30A LBS800-XX



- 1.Ratings:120V, 60Hz. Max. interconnected:24W
- 2 Plug/Couple connector:YJ-2F/SP03-1/SP03-2
- 3.The suffix "followed by up to two characters" denoted the number of LED bulbs, min. 2pcs YJ-SC15A-15LED bulbs, YJ-SC15AO-15LED bulbs, YJ-SC30A-30LED bulbs
- 4.The main line:SJTW 2/C 18AWG and 21996 3/C 20AWG

美规智能彩灯灯串

AT1450



- 1.Ratings:120V, 60Hz. Max. interconnected:24W
- 2.Plug/Couple connector:YJ-2F/SP03-1/SP03-2
- 3.The suffix "followed by up to two characters" denoted the number of LED bulbs, min. 2pcs
- 4.The main line:21996 3/C 22AWG

美规智能彩灯灯串

YJ-312-B22XX



- 1.Ratings:120V, 60Hz. Max. interconnected:24W
- 2.Plug/Couple connector:Y J-2F/SP03-1/SP03-2
- 3.The suffix "followed by up to two characters" denoted the number of LED bulbs, min. 2pcs
- 4.The main line:SJTW 3/C 18AWG and 21996 3/C 20AWG
- 5.The bulb type:The acrylic material diamond shape buible

美规智能彩灯灯串

AT1326-12 AT1308-18 AT1438-24



- 1.Ratings:120V 60Hz Max. interconnected:432W,
- 2.Plug/Receptacle:YJ-2F/SP05
- 3.Cord:SJTW 5/C 18AWG and 21996 5/C 20AWG

美规智能彩灯灯串

YJ1451



- 1.Ratings:120V, 60Hz. Max. interconnected:24W
- 2.Plug/Couple connector:YJ-2F/SP03-1/SP03-2
- 3.The suffix "followed by up to two characters" denoted the number of LED bulbs, min. 2pcs
- 4.The main line:21996 3/C 22AWG

美规智能彩灯灯串

YJ1453



- 1.Ratings:120V, 60Hz Max. interconnected:24W
- 2.Plug/Couple connector;YJ-2F/SP03-1/SP03-2
- 3.The suffix "followed by up to two characters" denoted the number of LED bulbs, min. 2pcs
- 4.The main line:21996 3/C 22AWG

太阳能灯串

E12



1. Color or Warm White light
2. Built in Battery:3.7V 2200mAh Lithium battery 2pcs
3. Solar Panel:5.5V 3W frosted laminated PET
- 4.E12 G40 LED Bulbs ,
5. Cord:SPT-1W 2/C 20AWG
- 6.USB Charge Current:5V 1A/H



YJCP-1



太阳能灯串

E26/E27



1. Warm White light
2. Built in Battery:3.7V 2200mAh Lithium battery 1pcs Solar, Panel:5.5V1.5W frosted laminated PET
3. Built in Battery:3.7V 2200mAh Lithium battery 2pcs Solar, Panel:5.5V3W frosted laminated PET
- 4.E26 S14 PC LED Bulbs
5. Cord:SPT-1W 2/C 20AWG or 2468 2/C 22AWG or 21996 2/C 22AWG
- 6.USB Charge Current:5V 1A/H



YJCP-2



YJCP-3



YJCP-5



YJCP-4



YJCP-6



YJCP-7



YJCP-8

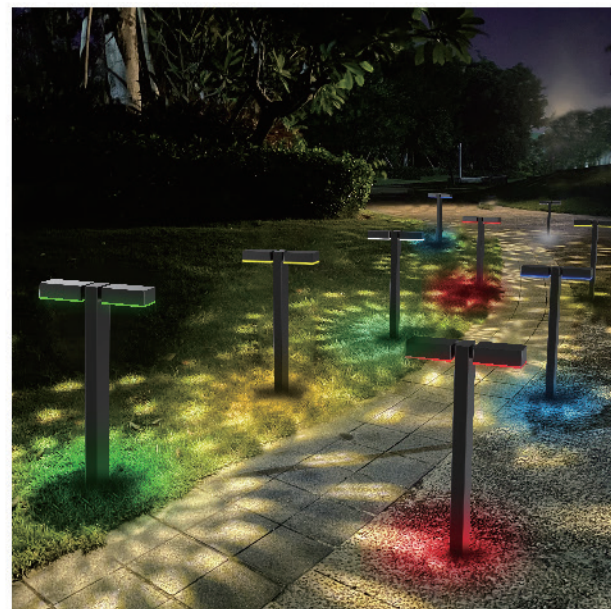

灯串 LAMP STRING D02-1



灯串 LAMP STRING D02-2



灯串 LAMP STRING D02-3



灯串 LAMP STRING D02-4



灯串 LAMP STRING D02-5



灯串 LAMP STRING D02-6



灯串 LAMP STRING D07-1



灯串 LAMP STRING D08-1



灯串 LAMP STRING D02-7



灯串 LAMP STRING D02-8



灯串 LAMP STRING YJ-23FCP-1



灯串 LAMP STRING YJ-40F



灯串 LAMP STRING D02-9



灯串 LAMP STRING D02-10



灯串 LAMP STRING P01-1



灯串 LAMP STRING P02-1



灯串 LAMP STRING D02-11



灯串 LAMP STRING D05-1



灯串 LAMP STRING P03-1



灯串 LAMP STRING P04-1



灯串 LAMP STRING P05-1



灯串 LAMP STRING P06-1



灯串 LAMP STRING P08-1



灯串 LAMP STRING P08-2



灯串 LAMP STRING P09-1



灯串 LAMP STRING P12-7



灯串 LAMP STRING P13-1



灯串 LAMP STRING P14-1



灯泡 LIGHT BULB

灯泡 Light bulb





云锦电器

灯头系列

Lampholder Series

灯头系列 LAMPHOLDER SERIES

D01 E26/E27 Droplight 吊灯小款

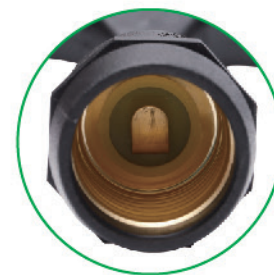

灯头系列 LAMPHOLDER SERIES

D02 E26/E27 Droplight 吊灯大款



灯头系列 LAMPHOLDER SERIES

D03 E26/E27 Droplight 吊灯



灯头系列 LAMPHOLDER SERIES

D04 B22 Droplight 吊灯



灯头系列 LAMPHOLDER SERIES

D05 E26/E27 Droplight 吊灯

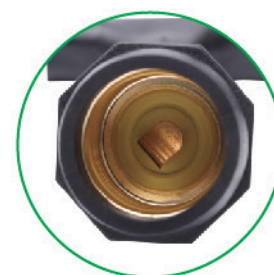

灯头系列 LAMPHOLDER SERIES

D06 E26/E27 Droplight 外螺纹款



灯头系列 LAMPHOLDER SERIES

D07 E26/E27 Droplight 吊灯



灯头系列 LAMPHOLDER SERIES

D08 E12 Droplight 吊灯



灯头系列 LAMPHOLDER SERIES

D09 E26/E27 Droplight 吊灯



灯头系列 LAMPHOLDER SERIES

D10 E26/E27 Droplight 吊灯



灯头系列 LAMPHOLDER SERIES

P01 E12 Flatlight 平灯



灯头系列 LAMPHOLDER SERIES

P02 E26/E27 Flatlight 平灯



灯头系列 LAMPHOLDER SERIES

P03 E26/E27 Flatlight 平灯



灯头系列 LAMPHOLDER SERIES

P04 E26/E27 Flatlight 平灯

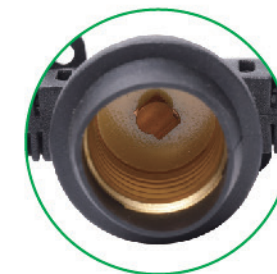

灯头系列 LAMPHOLDER SERIES

P05 E26/E27 Flatlight 平灯



灯头系列 LAMPHOLDER SERIES

P06 B22 Flatlight 平灯



灯头系列 LAMPHOLDER SERIES

P07 E26/E27 Flatlight 平灯



灯头系列 LAMPHOLDER SERIES

P08 E26/E27 Flatlight 平灯



灯头系列 LAMPHOLDER SERIES

P09 E26/E27 1450



灯头系列 LAMPHOLDER SERIES

P10 E12 Flatlight 平灯



灯头系列 LAMPHOLDER SERIES

P11 E26/E27 Flatlight 平灯



灯头系列 LAMPHOLDER SERIES

P12 E26/E27 Flatlight 平灯



灯头系列 LAMPHOLDER SERIES

P13 E12 Flatlight 平灯



灯头系列 LAMPHOLDER SERIES

P14 2.3插针注塑灯座



灯头系列 LAMPHOLDER SERIES

P15 E26/E27 Flatlight 平灯



灯头系列 LAMPHOLDER SERIES

P16 E26/E27 Flatlight 平灯



YUN 云锦电器

连接公母头系列

Male and female head connection series

连接公母头系列 MALE AND FEMALE HEAD CONNECTION SERIES

GMT-1

YJ-23MRGB/YJ-23FRGB



2PIN

12VDC Max.3A

AWM 2468 22AWGX2C

AWM21996 22- 20AWGX2C

CPE 2x0.3-0.5mm²

GMT-2

YJ-23M/YJ-23F



2PIN

100-240V~, 10A, 50/60Hz IP65
AWM21996 22-20AWGX2C
CPE 2X0.3-0.5mm²
SJTW/SJT/SVT 18/16AWGX2C
H05VV-F 2X0.75-1.5mm²
H07RN-F 2X1.0-1.5mm²

GMT-3

YJ-23M3/YJ-23F3



3PIN

DC and AC use
AWM21996 22-20AWGX3C
CPE 3X0.3-0.5mm²
H05VV-F 3x0.75-1.5mm²
H05RN-F 3x0.75-1.0mm²
H07RN-F 3x1.0-1.5mm²
SJTW/SJT/SVT 18/16AWGX3C

GMT-4

YJ-23M4/YJ-23F4



4PIN

DC and AC use
AWM21996 22-20AWGX4C
CPE 4x0.3-0.5mm²
H05VV-F 4x0.75mm²

GMT-5

YJ-15M5/YJ-15F5



5PIN

DC and AC use
AWM21996 22-20AWGX5C
CPE 5x0.3-0.5mm²
H05VV-F 5x0.75mm²
SJTW 18AWGX5C

GMT-6

YJ-23MCP/YJ-23FCP



2PIN

100-240V~, 10A, 50/60Hz, IP67
H05VV-F 2X0.75~1.5mm²
H05RN-F 2X0.75~1.0mm²
H07RN-F 2X1.0-1.5mm²
SJTW/SJT/SVT 18/16AWGX2C

GMT-7

YJ-23MCP1/YJ-23FCP1



2PIN

100-240V~, 10A, 50/60Hz, IP67
H05VV-F 2X0.75~1.5mm²
H05RN-F 2X0.75~1.0mm²
H07RN-F 2X1.0-1.5mm²
SJTW/SJT/SVT 18/16AWGX2C

GMT-8

YJ-40M/YJ-40F



2PIN

DC and AC use
AWM21996 20AWGX2C
H05VV-F 2X0.75-1.5mm²
H05RN-F 2X0.75-1.0mm²
H07RN-F 2X1.0-1.5mm²
SJTW/SJT/SVT 18/16/14AWGX2C

GMT-9

YJ-23M2/YJ-23F2



2PIN

DC and AC use
AWM21996 22-20AWGX2C
H05VV-F 2X0.75-1.5mm²
H05RN-F 2X0.75-1.0mm²
H07RN-F 2X1.0-1.5mm²
SJTW/SJT/SVT 18/16AWGX2C



三通连接系列 BRANCH CONNECTOR SERIES

ST-1

方形 老款三通



三通连接系列 BRANCH CONNECTOR SERIES

ST-2

圆形 短状 2芯线用



三通连接系列 BRANCH CONNECTOR SERIES

ST-3

圆形 细长 3芯线用



三通连接系列 BRANCH CONNECTOR SERIES

ST-4

圆形 B22用



三通连接系列 BRANCH CONNECTOR SERIES

ST-5

方形 网尾状



三通连接系列 BRANCH CONNECTOR SERIES

ST-6

方形 网尾状



三通连接系列 BRANCH CONNECTOR SERIES

ST-7

圆形 5芯用



三通连接系列 BRANCH CONNECTOR SERIES

ST-8

方形 草坪灯用



三通连接系列 BRANCH CONNECTOR SERIES

ST-9

方形 网尾状



三通连接系列 BRANCH CONNECTOR SERIES

ST-10

方形 带母头



三通连接系列 BRANCH CONNECTOR SERIES

ST-11

Y形 电源线三通



三通连接系列 BRANCH CONNECTOR SERIES

ST-12

一出 三灯头用



三通连接系列 BRANCH CONNECTOR SERIES

ST-13

方形 网尾状



三通连接系列 BRANCH CONNECTOR SERIES

ST-14

方形 网尾状





YUN 云锦电器

适配器系列

Power unit series

适配器系列 POWER UNIT SERIES

美规三孔彩灯适配器

CETLUS 适配器 36W



YJ-3

Input:120VAC,60Hz,0.2A;

Output:constant voltage 5VDC,max.2A 10W

YJ-312/YJ-SC1 5A/YJ-SC15AO,AT1450;

Input:120VAC,60Hz,0.4A;

Output:constant voltage 12VDC,max.2A 24W

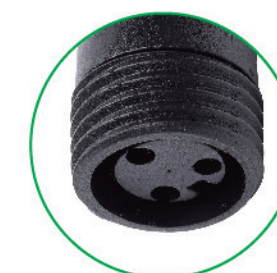

3PIN

适配器系列 POWER UNIT SERIES

美规二孔白灯适配器

CETLUS 适配器 24W



YJ-2/YJ-SW15A/YJ-SW15AO/AT1327

12VDC, MAX.3A 36W



2PIN

适配器系列 POWER UNIT SERIES

欧规三孔彩灯适配器

CETLUS 适配器 24W



YJ-3/YJ-312/YJ-SC15A/YJ-SC15AO/

YJ-SC15E/YJ-SC15EO/AT1450/YJ1450

12VDC, 24W, ClassIII, IP65, TA:25°C

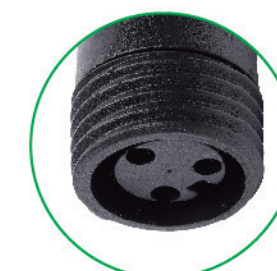

3PIN

欧规二孔白灯适配器

CETLUS 适配器 36W



YJ-2/YJ-SW15A/YJ-SW15AO/YJ-SW15E/YJ-SW15EO
12VDC, 36W, ClassIII, IP65, TA:25°C



2PIN

美规三孔插头适配器

YJ-312A



12VDC 24W



3PIN

YJ-5



YJ-5/AT1326/AT1308/AT1438
120VAC, 60Hz, 0.2A
Constant Voltage 5VDC, Max.2A, Class2
120VAC, Max.5A

澳式适配器插头

YJ-312AU



12VDC 24W

欧规三孔插头适配器

YJ-312E



12VDC 24W



3PIN

RGB款三孔连接适配器

YJ-312RGB



12VDC 24W



3PIN

英规三孔插头适配器

YJ-312U



12VDC 24W



3PIN

澳规二孔白灯适配器

—



YJ-2/YJ-SW15A/YJ-SW15AO/
YJ-SW15E/YJ-SW15EO
12VDC, ta25°C, IP65, 36W, ClassIII



2PIN

适配器系列 POWER UNIT SERIES

澳规二孔白灯适配器



YJ-3/YJ-312/YJ-SC15A/YJ-SC15AO/
YJ-SC15E/YJ-SC15EO
12VDC, ta25°C, IP65, 24W, ClassIII



3PIN

适配器系列 POWER UNIT SERIES

YJ-3AC高压调光器



120VAC 60Hz 400W
2-POLE3-WIRE PLUG 5- 15P
SJTW 18/16/14AWGX3C

YUN 云锦电器

取电线

Take wire

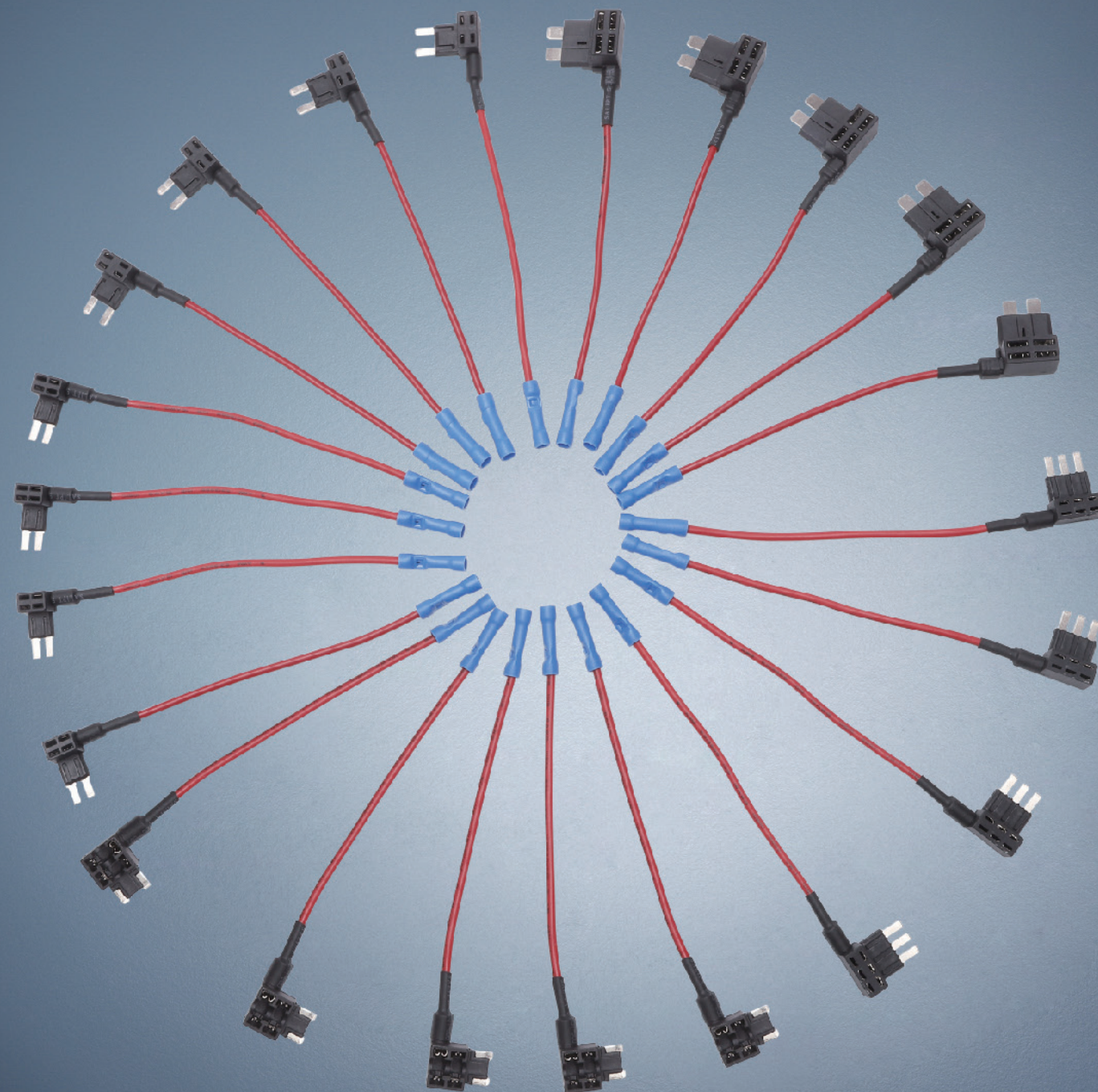

取电线 TAKE WIRE

YJ-C-01



取电线 TAKE WIRE

YJ-C-03



取电线 TAKE WIRE

YJ-C-02



取电线 TAKE WIRE

YJ-C-04



取电线 TAKE WIRE

YJ-C-05



取电线 TAKE WIRE

YJ-C-06



取电线 TAKE WIRE

取电线 Take wire





YUN 云锦电器

美国标准插头座系列

Plugs to the American Standard

美国标准插头座系列 AMERICAN PLUG SERIES

YJ-2F

2-POLE2-WIRE PLUG 1-15P (With 5A Fuse)



18/2---SJT/SJTW/SVT

美国标准插头座系列 AMERICAN PLUG SERIES

YJ-2FA

2-POLE2-WIRE PLUG 1-15P (With 5A Fuse)



18/2 SJT/SJTW/SVT

美国标准插头座系列 AMERICAN PLUG SERIES

YJ-2

2-POLE2-WIRE PLUG 1-15P



18/2C---SJT/SJTW/SVT
17/2C---SVT
16/2C---SJT/SJTW/SVT
14/2C---SJT/SJTW
12/2C---SJT/SJTW

美国标准插头座系列 AMERICAN PLUG SERIES

YJ-2A(JT-2)

2-POLE2-WIRE PLUG 1-15P



SVT, SVTO, SVTOO 18/17/16AWGX2C
SJT, SJTO, SJTOO, SJTW, SJTOW
SJTOOW 18/16/14AWGX2C
SPT-1 18AWGX2C
SPT-2 18/16AWGX2C
SPT-3 18/16/14AWGX2C

美国标准插头座系列 AMERICAN PLUG SERIES

YJ-2FC(JT-2FC)

2-POLE2-WIRE PLUG 1-15P (With 8A Fuse)



18/2C---SJT/SJTW/SVT

美国标准插头座系列 AMERICAN PLUG SERIES

YJ-2K(JT-2K)

2-POLE2-WIRE PLUG 1-15P

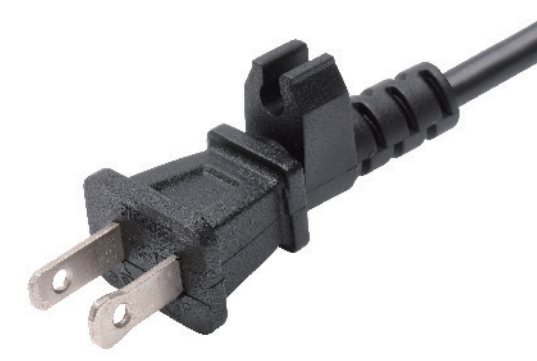

SVT, SVTO, SVTOO 18/17/16AWGX2C
SJT, SJTO, SJTOO, SJTW, SJTOW
SJTOOW 18/16AWGX2C

美国标准插头座系列 AMERICAN PLUG SERIES

FY-2A

2-POLE2-WIRE PLUG 1-15P



18/2C HPN, SPT-1, SPT-2, SPT-3, NISPT-1
NISPT-2, SVT, SVTO, SVTOO, SJT, SJTO
SJTOO, SJTW, SJTOW, SJTOOW
17/2C SVT, SVTO, SVTOO
16/2C HPN, SPT-2, NISPT-2, SPT-3, SVT
SVTO, SVTOO, SJT, SJTO, SJTOO, SJTW, SJTOW, SJTOOW
14/2C SPT-3, SJT, SJTO, SJTOO, SJTW, SJTOW, SJTOOW

美国标准插头座系列 AMERICAN PLUG SERIES

JT-2F

1-15P



18/2C SJT, SJTO, SJTOO, SJTW, SJTOW, SJTOOW
16/2C SJT, SJTO, SJTOO, SJTW, SJTOW, SJTOOW
14/2C SJT, SJTO, SJTOO, SJTW, SJTOW, SJTOOW

美国标准插头座系列 AMERICAN PLUG SERIES

YJ-2ZF(JT-2ZF)

2-POLE2-WIRE PLUG 1-15R



18/2---SJT/SJTW/SVT

美国标准插头座系列 AMERICAN PLUG SERIES

SP05

2-Conductor Cord 1-15R



18/2---SJT/SJTW/SVT

美国标准插头座系列 AMERICAN PLUG SERIES

YJ-2Z

2-Conductor Cord 1-15R



18/2C---SJT/SJTW/SVT
17/2C---SVT
16/2C---SJT/SJTW/SVT
14/2C---SJT/SJTW
12/2C---SJT/SJTW

美国标准插头座系列 AMERICAN PLUG SERIES

JT-2ZA

1-15R



16/2C SPT-2
14/2C SPT-2

美国标准插头座系列 AMERICAN PLUG SERIES

JT-2Z

1-15R



16/2C SPT-2
14/2C SPT-2

美国标准插头座系列 AMERICAN PLUG SERIES

FY-3P

2-POLE3-WIRE PLUG 5-15P



18/3C SPT-2, SPT-3, NISPT-2, SVT, SVTO
SVTOO, SJT, SJTO, SJTOO, SJTW, SJTOW, SJTOOW
17/3C SVT, SVTO, SVTOO
16/3C SPT-2, SVT, SVTO, SVTOO
SJT, SJTO, SJTOO, SJTW, SJTOW, SJTOOW
14/3C SJT, SJTO, SJTOO, SJTW, SJTOW, SJTOOW

美国标准插头座系列 AMERICAN PLUG SERIES

YJ2-3(JT2-3)

2-POLE3-WIRE PLUG 5-15P

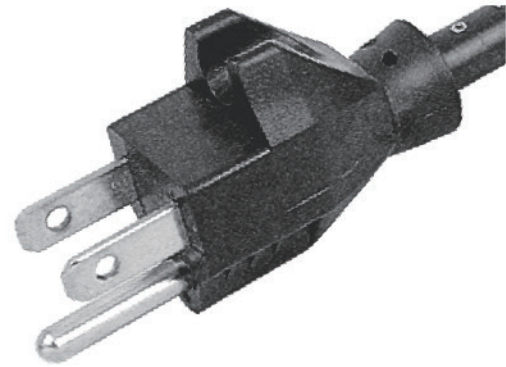

18/3C SVT, SVTO, SVTOO, SJT, SJTO, SJTOO, SJTW, SJTOW, SJTOOW
17/3C SVT, SVTO, SVTOO
16/3C SVT, SVTO, SVTOO, SJT, SJTO, SJTOO, SJTW, SJTOW, SJTOOW

美国标准插头座系列 AMERICAN PLUG SERIES

JT-3FC

2-POLE3-WIRE PLUG 5-15P



18/3C SJTW, SJTOW, SJTOOW, STW, STOW, STOOW
17/3C SJTW, SJTOW, SJTOOW
16/3C SJTW, SJTOW, SJTOOW, STW, STOW, STOOW
14/3C SJTW, SJTOW, SJTOOW, STW, STOW, STOOW
12/3C SJTW, SJTOW, SJTOOW

美国标准插头座系列 AMERICAN PLUG SERIES

YJ-3

2-POLE3-WIRE PLUG 5-15P



18/3C---SJT/SJTW/SVT
17/3C---SVT
16/3C---SJT/SJTW/SVT
14/3C---SJT/SJTW
12/3C---SJT/SJTW

美国标准插头座系列 AMERICAN PLUG SERIES

YJ-3A(JT-3)

2-POLE3-WIRE PLUG 5-15P



SVT, SVTO, SVTOO 18/17/16AWGX3C
SJT, SJTO, SJTOO, SJTW, SJTOW, SJTOOW
18/16/14/12AWGX3C

美国标准插头座系列 AMERICAN PLUG SERIES

YJ-3D(JT-3D)

2-POLE3-WIRE PLUG 5-15P

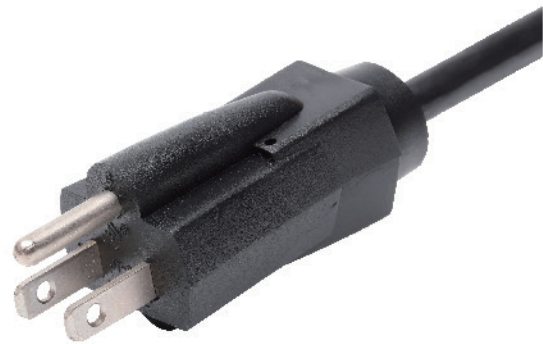

ST, STW, STOW 18/16/14/12AWGX3C

美国标准插头座系列 AMERICAN PLUG SERIES

YJ-3F

2-POLE3-WIRE PLUG 5-15P (With 8A Fuse)



18/3---SJT/SJTW/SVT

美国标准插头座系列 AMERICAN PLUG SERIES

YJ-3Q(FY-3Q)

2-POLE3-WIRE PLUG 5-15P



SVT, SVTO, SVTOO 18/17/16AWGX3C
SJT, SJTO, SJTOO, SJTW, SJTOW, SJTOOW
18/16/14AWGX3C

美国标准插头座系列 AMERICAN PLUG SERIES

JT-3A

5-15P

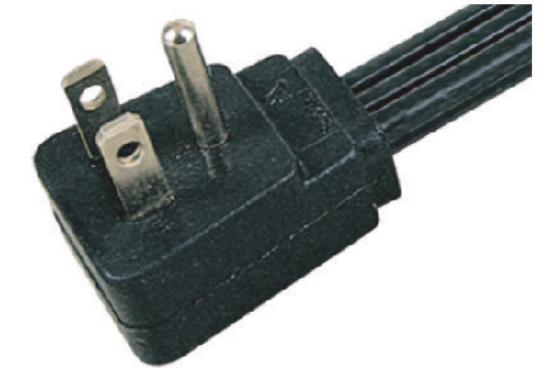

18/3C SPT-2, SPT-3, NISPT-2, SVT, SVTO, SVTOO, SJT, SJTO, SJTOO, SJTW, SJTOW, SJTOOW
17/3C VT, SVTO, SVTOO
16/3C SPT-2, SVT, SVTO, SVTOO
SJT, SJTO, SJTOO, SJTW, SJTOW, SJTOOW
14/3C SJT, SJTO, SJTOO, SJTW, SJTOW, SJTOOW

美国标准插头座系列 AMERICAN PLUG SERIES

JT-3B

5-15P



18/3C SPT-2, SPT-3, NISPT-2, SVT, SVTO
SVTOO, SJT, SJTO, SJTOO, SJTW, SJTOW, SJTOOW
17/3C SVT, SVTO, SVTOO
16/3C SPT-2, SVT, SVTO, SVTOO
SJT, SJTO, SJTOO, SJTW, SJTOW, SJTOOW
14/3C SJT, SJTO, SJTOO, SJTW, SJTOW, SJTOOW

美国标准插头座系列 AMERICAN PLUG SERIES

YJ-3FB

5-15P



18/3C SPT-2, SPT-3, SVT, SVTO, SVTOO
SJT, SJTO, SJTOO, SJTW, SJTOW, SJTOOW
17/3C SVT, SVTO, SVTOO
16/3C SPT-2, SPT-3, SVT, SVTO, SVTOO
SJT, SJTO, SJTOO, SJTW, SJTOW, SJTOOW
14/3C SJT, SJTO, SJTOO, SJTW, SJTOW, SJTOOW
12/3C SJT, SJTO, SJTOO, SJTW, SJTOW, SJTOOW

美国标准插头座系列 AMERICAN PLUG SERIES

FY-3R

5-15P



18/3C HPN HPN-R, SPT-2, SPT-2-R NISPT-2,
SPT-3, SVT, SVT-R SVTO, SVTO-R, SJT,
SJT-R SJTO, SJTO-R, SJTW, SJTW-R SJTOW, SJTOW-R
16/3C HPN HPN-R, SPT-2, SPT-2-R NISPT-2
SPT-3, SVT, SVT-R SVTO, SVTO-R, SJT
SJT-R SJTO, SJTO-R, SJTW, SJTW-R SJTOW, SJTOW-R

美国标准插头座系列 AMERICAN PLUG SERIES

YJ-3Z

3-Conductor Cord 5-15R



18/3C---SJT/SJTW/SVT
17/3C---SVT
16/3C---SJT/SJTW/SVT
14/3C---SJT/SJTW
12/3C---SJT/SJTW

美国标准插头座系列 AMERICAN PLUG SERIES

YJ-3ZB (JT-3ZB)

3-Conductor Cord 5-15R



SJTW, SJTOW, SJTOOW 16/14/12AWGX3C
STW, STOW, STOOW 16/14AWGX3C

美国标准插头座系列 AMERICAN PLUG SERIES

JT-3ZA

2-POLE3-WIRE PLUG 5-15R (With 8A Fuse)



14/3C SJTW, SJTOW, SJTOOW

美国标准插头座系列 AMERICAN PLUG SERIES

JT-3ZC

5-15R



16/3C SJTW, SJTOW, SJTOOW, STW, STOW, STOOW
14/3C SJTW, SJTOW, SJTOOW, STW, STOW, STOOW
12/3C SJTW, SJTOW, SJTOOW

美国标准插头座系列 AMERICAN PLUG SERIES

YJ2-3(JT2-3)

2-POLE2-WIRE PLUG 6-15P



SPT-2 18/16AWGX3C
SPT-3 18/16AWGX3C
SVT, SVTO, SVTOO 18/17/16AWGX3C
SJT, SJTO, SJTOO, SJTW, SJTOW, SJTOOW
18/16/14/12AWGX3C

美国标准插头座系列 AMERICAN PLUG SERIES

YJ2-3I(JT2-3I)

2-POLE 3-WIRE PLUG 6-20P

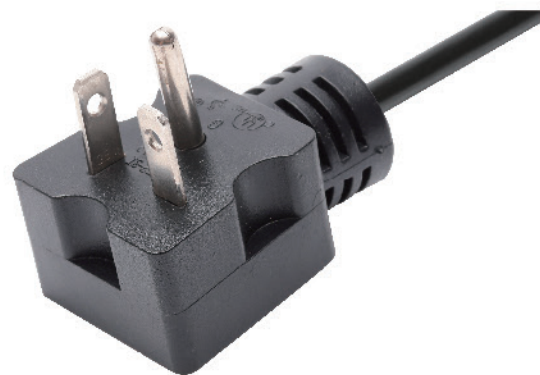

SPT-2 16AWGX3C
SPT-3, SJT, SJTO, SJTOO, ST, STO, STOO
16/14/12/10AWGX3C
SJTW, SJTOW, SJTOOW, STW, STOW, STOOW
16/14/12/10AWGX3C

美国标准插头座系列 AMERICAN PLUG SERIES

YJ-3B

2-POLE 3-WIRE PLUG 6-50P

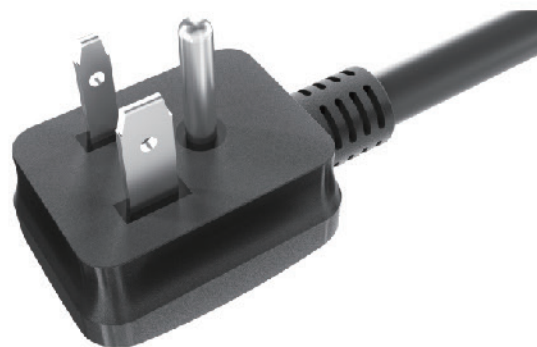

SJT, SJTW, SJTO, SJTOW, SJTOO, SJTOOW
S, SO, SOW, SOOW, ST, STW, STO, STOW
STOO, STOOO, SJW, SW, SJ, SJO, SJOW
SJOO, SJOOW 14/12/10AWGX3C

欧洲标准插头系列 EUROPEAN PLUG SERIES

YJ001(JT001)

2.5A 250V~



H03VV-F	2X0.50~0.75mm ²
H03VVH2-F	2X0.50~0.75mm ²
H03V2V2H2-F	2X0.50~0.75mm ²
H05VV-F	2X0.75~1.00mm ²
H05VVH2-F	2X0.75~1.00mm ²
H05V2V2H2-F	2X0.75~1.00mm ²
H05RN-F	2X0.75mm ²
H05RR-F	2X0.75mm ²
H05VV-F	2X0.75mm ²

欧洲标准插头系列 EUROPEAN PLUG SERIES

YJ002/B(JT002/B)

16A 250V~

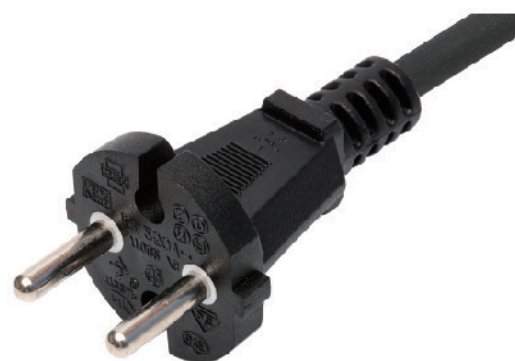

H05VVWH2-F	2X0.75~1.00mm ²
H05RN-F	2X0.75~1.00mm ²
H07RN-F	2X1.00~1.50mm ²
H03V2V2-F	2X0.50~0.75mm ²
H03V2V2H2-F	2X0.50~0.75mm ²
H05V2V2-F	2X0.75~1.00mm ²
H05V2V2H2-F	2X0.75~1.00mm ²

欧洲标准插头系列 EUROPEAN PLUG SERIES

YJ002A(JT002A)

16A 250V~

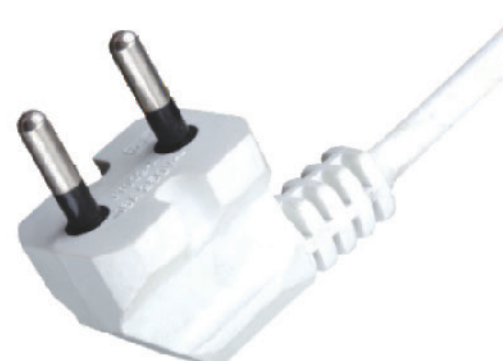

H05VV-F 2X1.00mm²

欧洲标准插头系列 EUROPEAN PLUG SERIES

YJ002-F(JT002-F)

16A 250V~IP44



H05VV-F	2x0.75mm ²
H05VV-F	2x1.0mm ²
H05VV-F	2x1.5mm ²
H05RN-F	2x0.75mm ²
H05RN-F	2x1.0mm ²
H07RN-F	2x1.0mm ²
H07RN-F	2x1.5mm ²



欧洲标准插头系列 EUROPEAN PLUG SERIES

YJ003(JT003)

16A 250V~



H03VV-F	3X0.50~0.75mm ²
H03V2V2-F	3X0.50~0.75mm ²
H05VV-F	3X0.75~1.5mm ²
H05V2V2H2-F	3X0.75~1.5mm ²
H05RN-F	3X0.75~1.00mm ²
H05RR-F	3X0.75~1.50mm ²
H07RN-F	3X1.00~1.50mm ²

欧洲标准插头系列 EUROPEAN PLUG SERIES

YJ003F(JT003F)

16A 250V~



H05VV-F	3X0.75~1.50mm ²
H05RN-F	3X0.75~1.00mm ²
H07RN-F	3X1.00~1.50mm ²

欧洲标准插头系列 EUROPEAN PLUG SERIES

YJ003-B(JT003-B)

16A 250V~



H03VV-F	3X0.50~0.75mm ²
H05VV-F	3X0.75~1.50mm ²
H05RR-F	3X0.75~1.50mm ²
H05RN-F	3X0.75~1.00mm ²
H07RN-F	3X1.00~1.50mm ²
H03V2V2-F	3X0.50~0.75mm ²
H05V2V2H2-F	3X0.75~1.5mm ²

欧洲标准插头系列 EUROPEAN PLUG SERIES

YJ005

16A 250V~

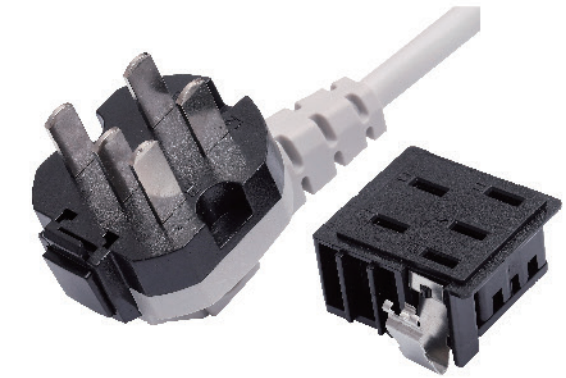

H05VV-F	5X0.75mm ²
---------	-----------------------

欧洲标准插头系列 EUROPEAN PLUG SERIES

YJ003-Z

16A 250V~ IP44



H05VV-F	3X1.0mm ²
H05VV-F	3X1.5mm ²
H05RN-F	3X1.0mm ²
H07RN-F	3X1.0mm ²
H07RN-F	3X1.5mm ²

欧洲标准插头系列 EUROPEAN PLUG SERIES

GZ2-6B

2.5A 250V~



H05VVH2-F	2X0.75~1.00mm ²
-----------	----------------------------

欧洲标准插头系列 EUROPEAN PLUG SERIES

YJ2000(JT2000)

16A 250V~



H05VV-F	3X1.50mm ²
---------	-----------------------

欧洲标准插头系列 EUROPEAN PLUG SERIES

GZ2-16

16A 250V~



H05VV-F	2X0.75~1.50mm ²
---------	----------------------------

欧洲标准插头系列 EUROPEAN PLUG SERIES

GZ3-16

16A 250V~



H05VV-F 3X1.00mm²
H05RR-F 3X1.00mm²
H07RN-F 3X1.00mm²

欧洲标准插头系列 EUROPEAN PLUG SERIES

GZ3-16B

16A 250V~



H05VV-F 3X1.00mm²
H05RR-F 3X1.00mm²
H07RN-F 3X1.00mm²

欧洲标准插头系列 EUROPEAN PLUG SERIES

FZF3-16

16A 250V~



H05VV-F 3X1.50mm²
H07RN-F 3X1.50mm²

欧洲标准插头系列 EUROPEAN PLUG SERIES

GZF3-16

16A 250V~



H05VV-F 3X1.00~1.50mm²
H07RN-F 3X1.00~1.50mm²

IEC连接器系列 IEC CONNECTOR SERIES

ST1

2.5A 250V~



H03VVH2-F 2X0.50~0.75mm²

IEC连接器系列 IEC CONNECTOR SERIES

ST2

2.5A 250V~



SPT-1 18AWGX2C
SPT-2 18AWGX2C
NISPT-1 18AWGX2C
NISPT-2 18AWGX2C
H03VVH2-F 2X0.50~0.75mm²
H05VVH2-F2 2X0.50~0.75mm²
4V-75250/250V 2X0.50~0.75mm²
4V-75250/440V 2X0.75mm²
602271IEC52(RVV) 2X0.50~0.75mm²
602271IEC53(RVV) 2X0.75mm²



云锦电器

IEC连接器系列

IEC Connector Series

IEC连接器系列 IEC CONNECTOR SERIES

ST2D

2.5A 250V~



H03VVH2-F 2X0.50~0.75mm²
H05VVH2-F 2X0.75mm²

IEC连接器系列 IEC CONNECTOR SERIES

ST3W

10A 250V~



SVT 18AWG X3C~16AWGX3C
SJT 18AWGX3C~14AWGX3C
4V-75250/440V 3X0.75~1.00mm²
602271IEC53(RVV) 3X0.75~1.00mm²

IEC连接器系列 IEC CONNECTOR SERIES

ST6

16A 250V~



H05VV-F 2X0.75~1.5mm²

IEC连接器系列 IEC CONNECTOR SERIES

ST6D

16A 250V~



H05VV-F 3X0.75~1.5mm²

IEC连接器系列 IEC CONNECTOR SERIES

JT-ST2

2.2A 250V~



H03VVH2-F 2X0.50~0.75mm²
4V-75250/250V 2X0.50~0.75mm²
602271IEC52(RVV) 2X0.50~0.75mm²

IEC连接器系列 IEC CONNECTOR SERIES

JT-ST2B

2.5A 250V~



SVT, SVTO, SVTOO, SJT, SJTO, SJTO, SJTOO 18, 16AWGX3C
H03VV-F 3X0.75mm²
H05VV-F 3X0.75mm²
4V-75250/250V 3X0.75mm²
4V-75250/440V 3X0.75mm²
602271IEC52(RVV) 3X0.75mm²
602271IEC53(RVV) 3X0.75mm²

IEC连接器系列 IEC CONNECTOR SERIES

JT-ST3

10A 250V~



SVT, SVTO, SVTOO 18, 16AWGX3C
SJT, SJTO, SJTO, SJTOO, SJTW, SJTOW
SJTOOW 18, 16, 14AWGX3C
H05VV-F 3X0.75~1.00mm²
4V-75250/440V 3X0.75~1.00mm²
602271IEC53(RVV) 3X0.75~1.00mm²

IEC连接器系列 IEC CONNECTOR SERIES

ST3-H

10A 250V~



H05RR-F 3X0.75~1.00mm²
H05RN-F 3X0.75~1.00mm²
H03RT-F 3X0.75~1.00mm²



YUN 云锦电器

日本标准插头系列

Plugs to the Japanese Standard

日本标准插头系列 JAPANESE PLUG SERIES

JF2-7/12/15



(H)VFF	2X0.75mm ²
(H)VCTF	2X1.25mm ²
(H)HVCTF	2X2.0mm ²
(H)VCT	

日本标准插头系列 JAPANESE PLUG SERIES

J3-7/12/15

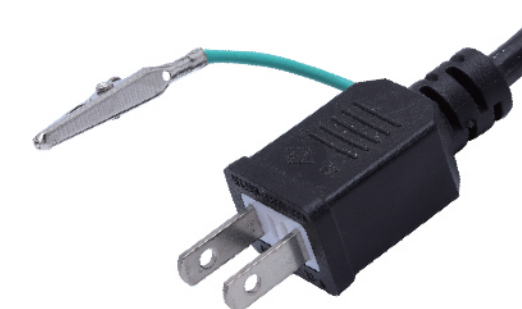

(H)VFF	3X0.75mm ²
(H)VCTF	3X1.25mm ²
(H)HVCTF	3X2.0mm ²
(H)VCT	

日本标准插头系列 JAPANESE PLUG SERIES

J3-7B/12B/15B

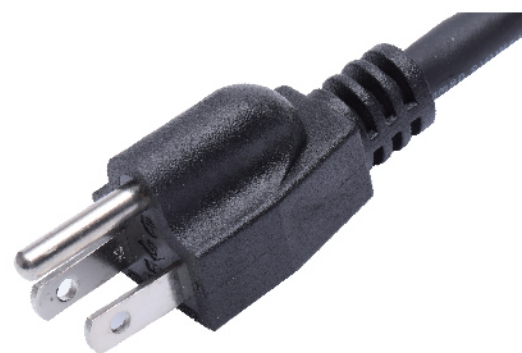

(H)VCTF	3X0.75mm ²
(H)HVCTF	3X1.25mm ²
(H)VCT	3X2.0mm ²

日本标准插头系列 JAPANESE PLUG SERIES

JF3-7/12/15



(H)VCTF	3X0.75mm ²
(H)HVCTF	3X1.25mm ²
(H)VCT	3X2.0mm ²

日本标准插头系列 JAPANESE PLUG SERIES

JZ2-7/12/15



(H)VFF	2X0.75mm ²
(H)VCTF	2X1.25mm ²
(H)HVCTF	2X2.0mm ²
(H)VCT	

日本标准插头系列 JAPANESE PLUG SERIES

JZF2-7/12/15



(H)VCTF	2X0.75mm ²
(H)HVCTF	2X1.25mm ²
(H)VCT	2X2.0mm ²

日本标准插头系列 JAPANESE PLUG SERIES

JZ2-7B/12B/15B



(H)VCTF	2X0.75mm ²
(H)HVCTF	2X1.25mm ²
(H)VCTFK	2X2.0mm ²
(H)VCT	

日本标准插头系列 JAPANESE PLUG SERIES

JZF3-7/12/15



(H)VCTF	3X0.75mm ²
(H)HVCTF	3X1.25mm ²
(H)VCT	4X2.0mm ²

日本标准插头系列 JAPANESE PLUG SERIES

J2-7/12/15

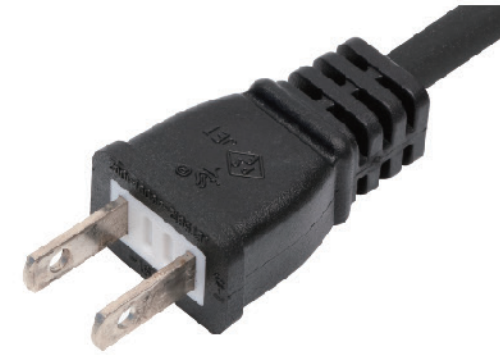

(H)VFF	
(H)VCTF	2X0.75mm ²
(H)HVCTF	2X1.25mm ²
(H)VCTFK	2X2.0mm ²

丹麦标准插头系列 DANISH PLUG SERIES

D3-16



H03VV-F	3X0.50~0.75mm ²
H03V2V2-F	3X0.50~0.75mm ²
H05VV-F	3X0.75~1.50mm ²
H05V2V2-F	3X0.75~1.50mm ²
H05RN-F	3X0.75~1.00mm ²
H05RR-F	3X0.75~1.50mm ²
H07RN-F	3X1.00~1.50mm ²

韩国标准插头系列 KOREAN PLUG SERIES

K2-15



H03VV-F	2X0.75mm ²
H03VVH2-F	2X0.75mm ²
H03V2V2-F	2X0.75mm ²
H03V2V2H2-F	2X0.75mm ²
H05VV-F	2X0.75~1.50mm ²
H05V2V2-F	2X0.75~1.50mm ²
H05V2V2H2-F	2X0.75~1.00mm ²
H05RN-F	2X0.75~1.50mm ²
H05RR-F	2X0.75~1.50mm ²
H07RN-F	2X1.00~1.50mm ²

韩国标准插头系列 KOREAN PLUG SERIES

K3-15



H03V-F	3X0.75mm ²
H05VV-F	3X0.75~1.50mm ²
H03V2V2-F	3X0.75mm ²
H05V2V2-F	3X0.75~1.50mm ²
H05RR-F	3X0.75~1.50mm ²
H05RN-F	3X0.75~1.50mm ²
H07RN-F	3X1.00~1.50mm ²

韩国标准插头系列 KOREAN PLUG SERIES

K2-3



H03VVH2-F	2X0.75mm ²
H05VVH2-F	2X0.75mm ²
H05VV-F	2X0.75mm ²
H03V2V2H2-F	2X0.75mm ²
H05V2V2H2-F	2X0.75mm ²
H05RR-F	2X0.75~1.00mm ²
H05RN-F	2X0.75~1.00mm ²

韩国标准插头系列 KOREAN PLUG SERIES

JT003



H03VV-F	3X0.75mm ²
H05VV-F	3X0.75~1.50mm ²
H03V2V2-F	3X0.75mm ²
H05V2V2-F	3X0.75~1.50mm ²
H05RR-F	3X0.75~1.50mm ²
H05RN-F	3X0.75~1.50mm ²
H07RN-F	3X1.00~1.50mm ²



YUN 云锦电器

中国标准插头系列

Plugs to the Chinese Standard

中国标准插头系列 CHINA PLUG SERIES

C2-6/10



IEC52(RVV)	2X0.50~0.75mm ²
IEC53(RVV)	2X0.75mm ²
IEC52(RVV)	2X0.75mm ²
IEC53(RVV)	2X0.75~1.00mm ²

中国标准插头系列 CHINA PLUG SERIES

C2-10B



IEC52(RVV)	2X0.75 mm ²
IEC53(RVV)	2X0.75~1.00mm ²

中国标准插头系列 CHINA PLUG SERIES

C3-6/10



IEC52(RVV)	3X0.50~0.75mm ²
IEC53(RVV)	3X0.75mm ²
IEC52(RVV)	3X0.75mm ²
IEC53(RVV)	3X0.75~1.00mm ²

中国标准插头系列 CHINA PLUG SERIES

C3-6C/10C



IEC52(RVV)	3X0.50~0.75mm ²
IEC53(RVV)	3X0.75mm ²
IEC53(RVV)	3X0.75~1.00mm ²

中国标准插头系列 CHINA PLUG SERIES

C2-6/10B



IEC52(RVV)	3X0.50~0.75mm ²
IEC53(RVV)	3X0.75mm ²
IEC52(RVV)	3X0.75mm ²
IEC53(RVV)	3X0.75~1.00mm ²

中国标准插头系列 CHINA PLUG SERIES

C3-16



IEC52(RVV)	3X0.75mm ²
IEC53(RVV)	3X0.75~1.50mm ²

中国标准插头系列 CHINA PLUG SERIES

C3-13C



IEC52(RVV)
IEC53(RVV)

3X0.75mm²
3X0.75~1.50mm²

中国标准插头系列 CHINA PLUG SERIES

P3-10



IEC53(RVV)

3X0.75~1.00mm²

中国标准插头系列 CHINA PLUG SERIES

C3-16P



IEC53(RVV)

3X0.75~1.50mm²

中国标准插头系列 CHINA PLUG SERIES

C3-10/JT-ST3

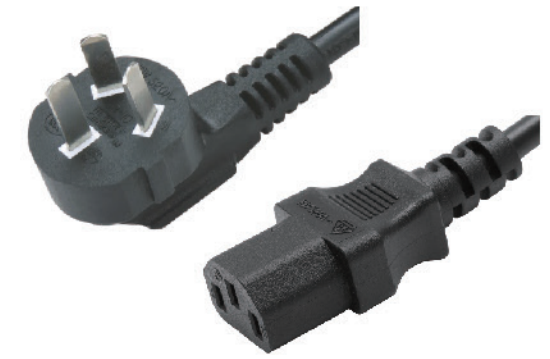

IEC53(RVV)

3X0.75~1.00 mm²

中国标准插头系列 CHINA PLUG SERIES

C3-10/ST3W

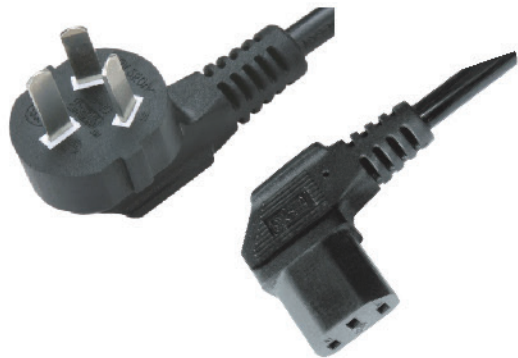

IEC53(RVV)

3X0.75~1.00mm²

中国标准插头系列 CHINA PLUG SERIES

C3-10B/ST3W

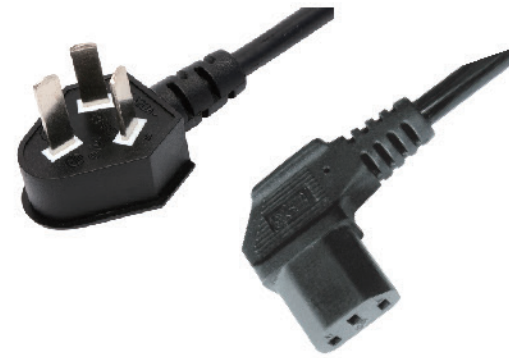

IEC53(RVV)

3X0.75~1.50mm²

中国标准插头系列 CHINA PLUG SERIES

C3-10B/JT-ST3



IEC53(RVV)

3X0.75~1.50mm²

中国标准插头系列 CHINA PLUG SERIES

C3-10C/JT-ST3



IEC53(RVV)

3X0.75~1.50mm²

中国标准插头系列 CHINA PLUG SERIES

C3-6/JT-ST2B



IEC52(RVV)

3X0.75mm²

中国标准插头系列 CHINA PLUG SERIES

C3-6B/JT-ST2B



IEC52(RVV)

3X0.75mm²

中国标准插头系列 CHINA PLUG SERIES

C2-6C/JT-ST2

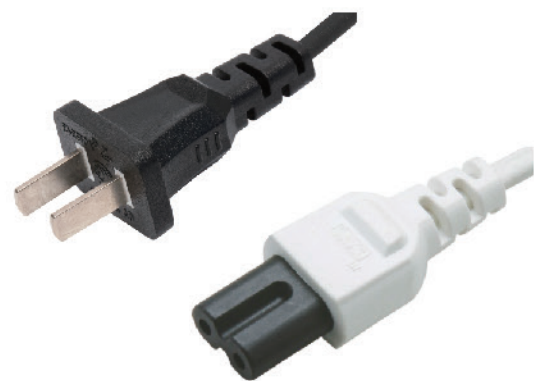

IEC52(RVV)

2X0.5~0.75 mm²

中国标准插头系列 CHINA PLUG SERIES

C3-6C/JT-ST2B



IEC52(RVV)

3X0.75 mm²

澳大利亚插头系列 AUSTRALIAN PLUG SERIES

A2-7/10

SAA



H03VV-F	2X0.50~0.75mm ²
H03VVH2-F	2X0.50~0.75mm ²
H05VV-F	2X0.75~1.00mm ²
H05VVH2-F	2X0.50~0.75mm ²
H07RN-F	2X1.00mm ²
H07VV-F	2X0.75~1.00mm ²
H05RN-F	2X0.75~1.00mm ²
H05RR-F	2X0.75~1.00mm ²
H07VV-F	2X0.75~1.50mm ²
H05RR-F	2X0.75~1.50mm ²
H05RN-F	2X1.00~1.50mm ²

澳大利亚插头系列 AUSTRALIAN PLUG SERIES

A3-7/10

SAA



H03VV-F	3X0.75mm ²
H05VV-F	3X0.75~1.50mm ²
H07VV-F	3X0.75~1.50mm ²
H05RR-F	3X0.75~1.50mm ²
H05RN-F	3X0.75~1.00mm ²
H07RN-F	3X1.00~1.50mm ²



YUN 云锦电器

澳大利亚标准插头系列

Plugs to the Australian Standard

澳大利亚插头系列 AUSTRALIAN PLUG SERIES

A3-10B

SAA



H03VV-F	3X0.75mm ²
H05VV-F	3X0.75~1.50mm ²
H07VV-F	3X0.75~1.50mm ²
H05RN-F	3X0.75~1.00mm ²
H05RR-F	3X0.75~1.50mm ²
H07RN-F	3X1.00~1.50mm ²

澳大利亚插头系列 AUSTRALIAN PLUG SERIES

A3-15

SAA



H05VV-F	3X1.00~2.50mm ²
H07VV-F	3X1.00~2.50mm ²
H05RN-F	3X1.00mm ²
H05RR-F	3X1.00~2.50mm ²
H07RN-F	3X1.00~2.50mm ²

澳大利亚插头系列 AUSTRALIAN PLUG SERIES

AZ3-10

SAA



H05VV-F	3X1.00~1.50mm ²
---------	----------------------------

澳大利亚插头系列 AUSTRALIAN PLUG SERIES

AZ3-15

250/440	3X1.00~2.50mm ²
0.6/1.2KV	3X1.00~2.50mm ²



南非标准插头系列 SOUTH AFRICAN PLUG

N3-6



H03VV-F	3X0.50~0.75mm ²
H03RT-F	3X0.75~1.00mm ²
H05VV-F	3X0.75~1.50mm ²
H05RN-F	3X0.75~1.00mm ²
H05RR-F	3X0.75~1.00mm ²

南非标准插头系列 SOUTH AFRICAN PLUG

N3-16



H03VV-F	3X0.75mm ²
H03RT-F	3X0.75~1.00mm ²
H05VV-F	3X0.75~1.50mm ²
H05RN-F	3X0.75~1.00mm ²
H05RR-F	3X0.75~1.00mm ²
H07RN-F	3X1.00~1.00mm ²





YUN 云锦电器

阿根廷/意大利标准插头系列

Plugs to the Argentina and Italy Standard

阿根廷标准插头系列 ARGENTINA PLUG SERIES

AR2-10B



H03VV-F	2X0.50~0.75mm ²
H03VVH2-F	2X0.50~0.75mm ²
H03V2V2-F	2X0.75mm ²
H03V2V2H2-F	2X0.50~0.75mm ²
H05VV-F	2X0.75~1.00mm ²
H05VVH2-F	2X0.75~1.00mm ²
H05V2V2-F	2X0.75~1.00mm ²
H05V2V2H2-F	2X0.75~1.00mm ²
H05RN-F	2X0.75~1.00mm ²
H05RR-F	2X0.75~1.00mm ²

阿根廷标准插头系列 ARGENTINA PLUG SERIES

AR2-10



H03VV-F	2X0.50mm ²
H03VVH2-F	2X0.50~0.75mm ²
H03V2V2-F	2X0.50~0.75mm ²
H03V2V2H2-F	2X0.50~0.75mm ²
H05VV-F	2X0.75~1.00mm ²
H05VVH2-F	2X0.75~1.00mm ²
H05V2V2-F	2X0.75~1.00mm ²
H05RN-F	2X0.75~1.00mm ²
H05RR-F	2X0.75~1.00mm ²
H07RN-F	2X1.00mm ²

阿根廷标准插头系列 ARGENTINA PLUG SERIES

AR3-10



H03VV-F	3X0.50~0.75mm ²
H03V2V2-F	3X0.50~0.75mm ²
H05VV-F	3X0.75~1.00mm ²
H05V2V2-F	3X0.75~1.00mm ²
H05RR-F	3X0.75~1.00mm ²
H05RN-F	3X0.75~1.00mm ²
H07RN-F	3X1.00mm ²
H03RT-H	3X0.75~1.00mm ²

意大利标准插头系列 ITALIAN PLUG SERIES

Y2-10



H03V-F	2X0.75mm ²
H03VVH2-F	2X0.75mm ²
H05VV-F	2X0.75~1.50mm ²
H05VVH2-F	2X0.75~1.00mm ²
H05RN-F	2X0.75~1.00mm ²
H05RR-F	2X0.75~1.00mm ²

意大利标准插头系列 ITALIAN PLUG SERIES

Y3-10

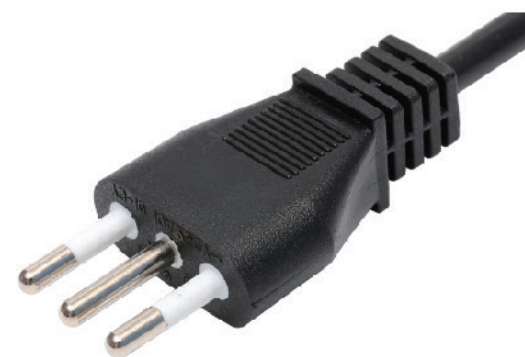

H03VV-F	3X0.75mm ²
H05V-F	3X0.75~1.50mm ²
H05RN-F	3X0.75~1.00mm ²
H05RR-F	3X0.75~1.50mm ²
H03RT-H	3X0.75~1.50mm ²

意大利标准插头系列 ITALIAN PLUG SERIES

Y3-16

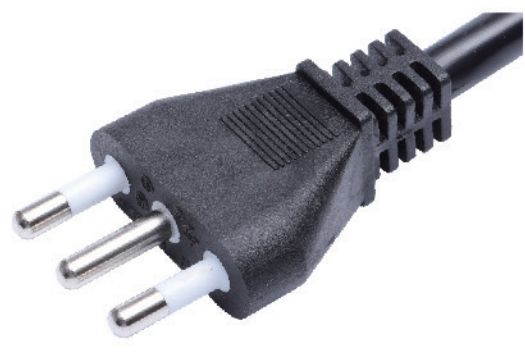

H05VV-F	3X1.00~1.50mm ²
H05RN-F	3X1.00~1.50mm ²
H05RR-F	3X1.00~1.50mm ²
H03RT-H	3X1.00~1.50mm ²
H05RN-F	3X1.00~1.50mm ²



YUN 云锦电器

瑞士/英国标准插头系列

Plugs to the Switzerl and British Standard

瑞士标准插头系列 SWISS PLUG SERIES

R2-10



H03VV-F	2X0.50~0.75mm ²
H03VVH2-F	2X0.50~0.75mm ²
H03V2V2-F	2X0.50~0.75mm ²
H03V2V2H2-F	2X0.50~0.75mm ²
H05VV-F	2X0.75~1.00mm ²
H05VVH2-F	2X0.75~1.00mm ²
H05V2V2-F	2X0.75~1.00mm ²
H05V2V2H2-F	2X0.75~1.00mm ²
H05RN-F	2X0.75~1.00mm ²
H05RR-F	2X0.75~1.00mm ²

瑞士标准插头系列 SWISS PLUG SERIES

R3-10

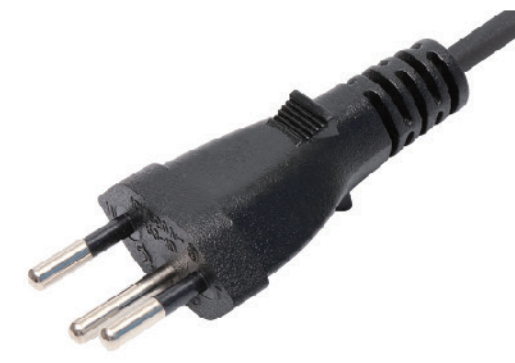

H03VV-F	3X0.50~0.75mm ²
H03V2V2-F	3X0.50~0.75mm ²
H05VV-F	3X0.75~1.00mm ²
H05V2V2-F	3X0.75~1.00mm ²
H05RR-F	3X0.75~1.00mm ²
H05RN-F	3X0.75~1.00mm ²
H03RT-H	3X0.75~1.50mm ²

瑞士标准插头系列 SWISS PLUG SERIES

R3-16

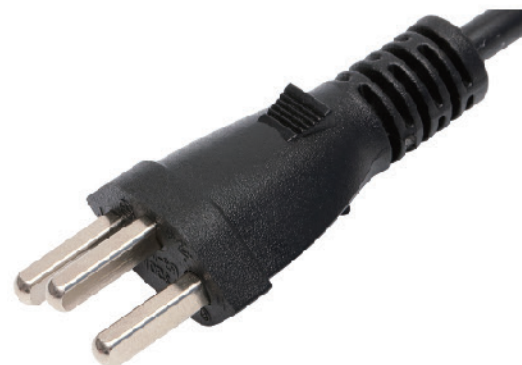

H03VV-F	3X0.75mm ²
H03RT-H	3X0.75~1.00mm ²
H05VV-F	3X0.75~1.50mm ²
H05V2V2-F	3X0.75~1.50mm ²
H05RR-F	3X0.75~1.50mm ²
H05RN-F	3X0.75~1.00mm ²
H07RN-F	3X0.75~1.50mm ²

英国标准插头系列 BRITISH PLUG SERIES

JT006A

SASO  COC

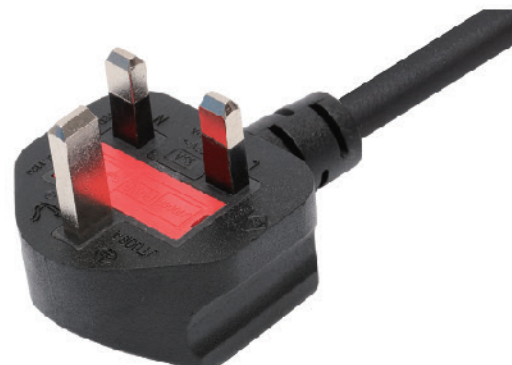

H03VV-F	2X0.50~0.75mm ² /3X0.50~0.75mm ²	H05V2V2H2-F	2X0.75~1.00mm ²
H03VVH2-F	2X0.50~0.75mm ²	H05RN-F	2X0.75~1.00mm ² /3X0.75~1.00mm ²
H03V2V2-F	2X0.50~0.75mm ² /3X0.50~0.75mm ²	H05RR-F	2X0.75~1.50mm ² /3X0.75~1.50mm ²
H03V2V2H2-F	2X0.50~0.75mm ² /3X0.75mm ²	H07RN-F	2X1.00~1.50mm ² /3X1.00~1.50mm ²
H05VV-F	2X0.75~1.5mm ² /3X0.75~1.50mm ²	A05VV-F	2X1.25mm ² /3X1.25mm ²
H05VVH2-F	2X0.75~1.00mm ²	A05RR-F	2X1.25mm ² /3X1.25mm ²
H05V2V2-F	2X1.00~1.50mm ² /3X0.75~1.50mm ²	A05RN-F	2X1.25mm ² /3X1.25mm ²

英国标准插头系列 BRITISH PLUG SERIES

FY006A

SASO  COC

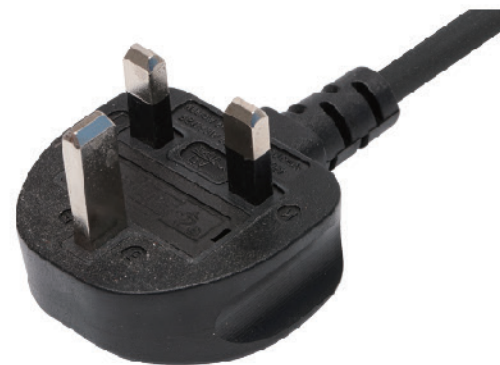

H03VV-F	2X0.50~0.75mm ² /3X0.50~0.75 mm ²	H05V2V2H2-F	2X0.75~1.00mm ²
H03VVH2-F	2X0.50~0.75mm ²	H05RN-F	2X0.75~1.00mm ² /3X0.75~1.00mm ²
H03V2V2-F	2X0.50~0.75mm ² /3X0.50~0.75mm ²	H05RR-F	2X0.75~1.50mm ² /3X0.75~1.50mm ²
H03V2V2H2-F	2X0.50~0.75mm ² /3X0.75mm ²	H07RN-F	2X1.00~1.50mm ² /3X1.00~1.50mm ²
H05VV-F	2X0.75~1.50mm ² /3X0.75~1.50mm ²	A05VV-F	2X1.25mm ² /3X1.25mm ²
H05VVH2-F	2X0.75~1.00mm ²	A05RR-F	2X1.25mm ² /3X1.25mm ²
H05V2V2-F	2X1.00~1.50mm ² /3X0.75~1.50mm ²	A05RN-F	2X1.25mm ² /3X1.25mm ²

英国标准插头系列 BRITISH PLUG SERIES

JT006

SASO  COC

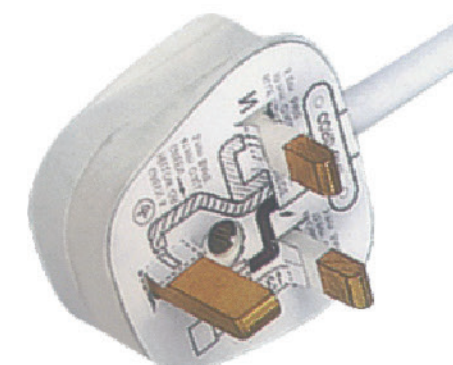

H03V-F	2X0.50~0.75mm ² /3X0.50~0.75mm ²	H05V2V2H2-F	2X0.75~1.00mm ²
H03VVH2-F	2X0.50~0.75mm ²	H05RN-F	2X0.75~1.00mm ² /3X0.75~1.00mm ²
H03V2V2-F	2X0.50~0.75mm ² /3X0.50~0.75mm ²	H05RR-F	2X0.75~1.50mm ² /3X0.75~1.50mm ²
H03V2V2H2-F	2X0.50~0.75mm ² /3X0.75mm ²	H07RN-F	2X1.00~1.50mm ² /3X1.00~1.50mm ²
H05VV-F	2X0.75~1.50mm ² /3X0.75~1.50mm ²	A05VV-F	2X1.25mm ² /3X1.25mm ²
H05VVH2-F	2X0.75~1.00mm ²	A05RR-F	2X1.25mm ² /3X1.25mm ²
H05V2V2-F	2X1.00~1.50mm ² /3X0.75~1.50mm ²	A05RN-F	2X1.25mm ² /3X1.25mm ²



YUN 云锦电器

以色列/巴西标准插头系列

Plugs to the Israel and Brazil Standard

以色列标准插头系列 ISRAEL PLUG SERIES

JY2-16



H03VV-F	2X0.75mm ²
H03VVH2-F	2X0.75mm ²
H03V2V2-F	2X0.50~0.75mm ²
H03V2V2H2-F	2X0.50~0.75mm ²
H05VV-F	2X0.75~1.00mm ²
H05VVH2-F	2X0.75~1.00mm ²
H05V2V2-F	2X0.75~1.50mm ²
H05V2V2H2-F	2X0.75~1.00mm ²
H05RN-F	2X0.75~1.00mm ²
H05RR-F	2X0.75~1.50mm ²
H07RN-F	2X0.75~1.00mm ²

以色列标准插头系列 ISRAEL PLUG SERIES

JY3-16

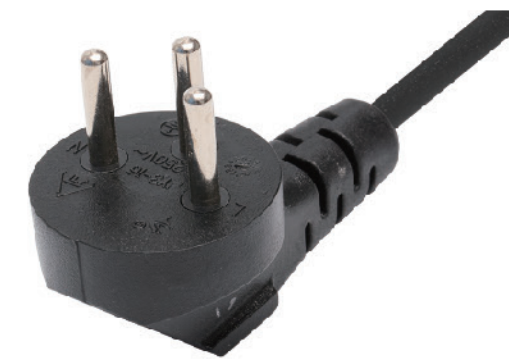

H03VV-F	3X0.75mm ²
H03V2V2-F	3X0.75mm ²
H05VV-F	3X0.75~1.50mm ²
H05V2V2-F	3X0.75~1.50mm ²
H05RN-F	3X0.75~1.00mm ²
H05RR-F	3X0.75~1.50mm ²

巴西标准插头系列 BRAZILIAN PLUG SERIES

BY2-10



H05VV-F	2X1.00~1.50mm ²
H05VVH2-F	2X1.00mm ²
H05V2V2-F	2X1.00~1.50mm ²
H05V2V2H2-F	2X1.00mm ²
H05RN-F	2X1.00mm ²
H05RR-F	2X1.00~1.50mm ²
H07RN-F	2X1.00~1.50mm ²

巴西标准插头系列 BRAZILIAN PLUG SERIES

B2-20



H03V-F	2X0.50~0.75mm ²
H03VVH2-F	2X0.50~0.75mm ²
H03V2V2-F	2X0.50~0.75mm ²
H03V2V2H2-F	2X0.50~0.75mm ²
H05VV-F	2X0.75~1.00mm ²
H05V2V2-F	2X0.75~1.50mm ²
H05V2V2H2-F	2X0.75~1.00mm ²
H05RN-F	2X0.75~1.00mm ²
H05RR-F	2X0.75~1.50mm ²
H07RN-F	2X1.00mm ²

巴西标准插头系列 BRAZILIAN PLUG SERIES

B3-10



H03VV-F	3X0.50~0.75mm ²
H03V2V2-F	3X0.50~0.75mm ²
H05VV-F	3X0.75~1.50mm ²
H05V2V2-F	3X0.75~1.50mm ²
H05RN-F	3X0.75~1.00mm ²
H05RR-F	3X0.75~1.50mm ²
H07RN-F	3X1.00mm ²
H03RT-H	3X0.75~1.50mm ²

巴西标准插头系列 BRAZILIAN PLUG SERIES

B3-20

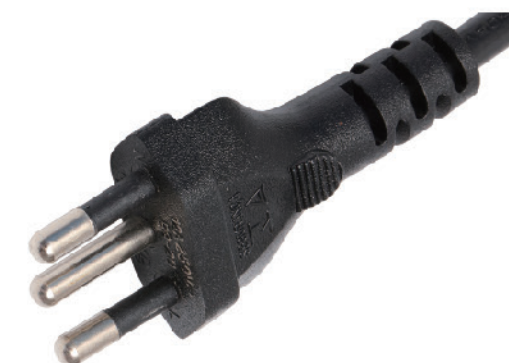

H05VV-F	3X1.00~1.50mm ²
H05V2V2-F	3X1.00~1.50mm ²
H05RN-F	3X1.00mm ²
H05RR-F	3X1.00~1.50mm ²
H07RN-F	3X1.00~1.50mm ²

线缆技术资料

ELECTRON TECHNICAL INFORMATION



60227IEC06(RV), 60227IEC02(RV), 60227IEC08(RV-90) H05V-K, H05V2-K, H07V-K, H07V2-K					
Conductor		Insulation (mm)		Max conductor resistance at 20°C Ω/KM	
Area	Construction	Thickness	OD	Bare	Tinned
0.5	28/0.15	0.6	2.3	39.0	40.1
0.75	42/0.15		2.4	26.0	26.7
1.0	32/0.20		2.6	19.5	20.0
1.5	48/0.20	0.7	3.1	13.3	13.7
2.5	80/0.20	0.8	3.8	7.98	8.21
4.0	56/0.30	0.8	4.2	4.95	5.09

CCC
VDE

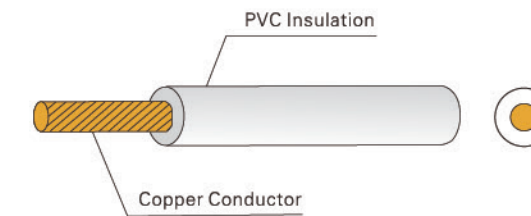

Model	Conductor		Insulation (mm)		Rating	
	Area	Construction	Thickness	OD		
1007	24	13/0.15	0.38	1.5	80°C 300VAC	
	22	19/0.15		1.6		
	20	30/0.15		1.8		
	18	47/0.15		2.0		
	16	42/0.20		2.3		
1015	24	13/0.15	0.76	2.2	80°C 90°C 105°C 600VAC	
	22	19/0.15		2.3		
	20	30/0.15		2.5		
	18	47/0.15		2.8		
	16	42/0.20		3.1		
	14	66/0.20		3.5		
	12	47/0.30		4.0		
1672	24	13/0.15	0.76	0.38	2.9	105°C 300VAC
	22	19/0.15			3.1	
	20	30/0.15			3.5	
	18	47/0.15			3.5	
	16	42/0.20			3.8	
	14	66/0.20			4.2	
	12	47/0.30			4.7	
	10	75/0.30			5.3	



60227IEC52, H03VV(H2)-F, H03V2V2(H2)-F(Light duty flexible cords)					
Conductor		insulation (mm)		Sheath	
No.	Area	Thickness	OD	Thickness	OD
2	0.5	0.5	2.0	0.6	5.1
	0.5		2.0		3.4×5.4
	0.75		2.2		5.5
	0.75		2.2		3.5×5.7
3	0.5	0.5	2.0	0.6	5.4
	0.75		2.2		5.8
60227IEC53, H05VV(H2)-F, H05V2V2(H2)-F(Ordinary duty flexible cords)					
2	0.75	0.6	2.3	0.8	6.3
	1.0		2.5		4.1×6.5
	1.5		3		6.7
	2.5		3.7		4.3×6.8
3	0.75	0.6	2.3	0.8	7.8
	1.0		2.5		9.5
	1.5		3		6.8
	2.5		3.7		7.2
4	0.75	0.6	2.3	0.8	8.2
	1.0		2.5		9.8
	1.5		3		10.2
	2.5		3.7		11.2
5	0.75	0.6	2.3	0.8	11.2
	1.0		2.5		8.1
	1.5		3		8.6
	2.5		3.7		10.7
6	0.75	0.6	2.3	0.8	12.4
	1.0		2.5		12.4
	1.5		3		10.7
	2.5		3.7		12.4
A05VV-F(Ordinary duty flexible cords)					
2	1.25	0.7	2.9	0.8	7.5
3	1.25		2.9	0.9	8.1
H07VV-F (Heavy duty flexible cords)					
2	0.75	0.8	2.8	1.3	8.2
	1.0		3.0		8.6
	1.5		3.3		9.6
	2.5		4.0		11.4
3	0.75	0.8	2.8	1.4	8.9
	1.0		3.0		9.3
	1.5		3.3		10.4
	2.5		4.0		12.3
4	0.75	0.8	2.8	1.5	9.8
	1.0		3.0		10.3
	1.5		3.3		11.4
	2.5		4.0		13.5
5	0.75	0.8	2.8	1.6	10.8
	1.0		3.0		11.3
	1.5		3.3		12.6
	2.5		4.0		14.8

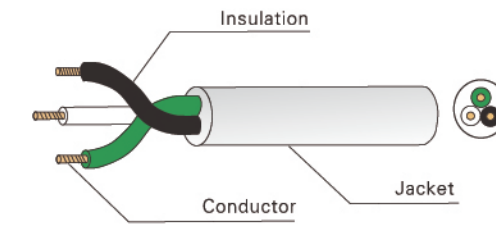

60245IEC53, H05RR-F, 60245IEC57, H05RN-F, 05RN8-F (Ordinary duty flexible cords)					
2	0.75	0.6	2.4	0.8	6.4
	1.0		2.6	0.9	7.2
	1.5		3.3	1.0	8.1
	2.5		4.0	1.1	10.2
3	0.75	0.6	2.4	0.9	7.0
	1.0		2.6	1.0	7.6
	1.5		3.3	1.0	9.2
	2.5		4.0	1.1	10.8
4	0.75	0.6	2.4	0.9	7.6
	1.0		2.6	0.9	8.3
	1.5		3.3	1.1	10.2
	2.5		4.0	1.2	12.1
5	0.75	0.6	2.4	1.0	8.5
	1.0		2.6	1.1	9.3
	1.5		3.3	1.1	11.5
	2.5		4.0	1.3	13.4
A05RR-F, A05RN-F(Ordinary duty flexible cords)					
2	1.25	0.8	3.1	1.0	8.2
3	1.25		3.1	1.0	8.7
60245IEC66, H07RN-F, H07RN8-F (Heavy duty flexible cords)					
2	1.0	0.8	3.1	1.3	8.8
	1.5		3.3	1.4	9.4
	2.5		4.1	1.7	11.6
3	1.0	0.8	3.1	1.4	9.5
	1.5		3.3	1.6	10.4
	2.5		4.1	1.8	12.6
4	1.0	0.8	3.1	1.5	10.7
	1.5		3.3	1.7	11.4
	2.5		4.1	1.9	13.7
5	1.0	0.8	3.1	1.6	11.6
	1.5		3.3	1.8	12.6
	2.5		4.1	2.0	15.1
60245IEC51, H03RT-H					
2	0.75	0.8	2.8	6.6	VDE
	1.0		3.1	6.9	
	1.5		3.3	7.4	
3	0.75	0.8	2.8	7.0	
	1.0		3.1	7.4	
	1.5		3.3	7.9	

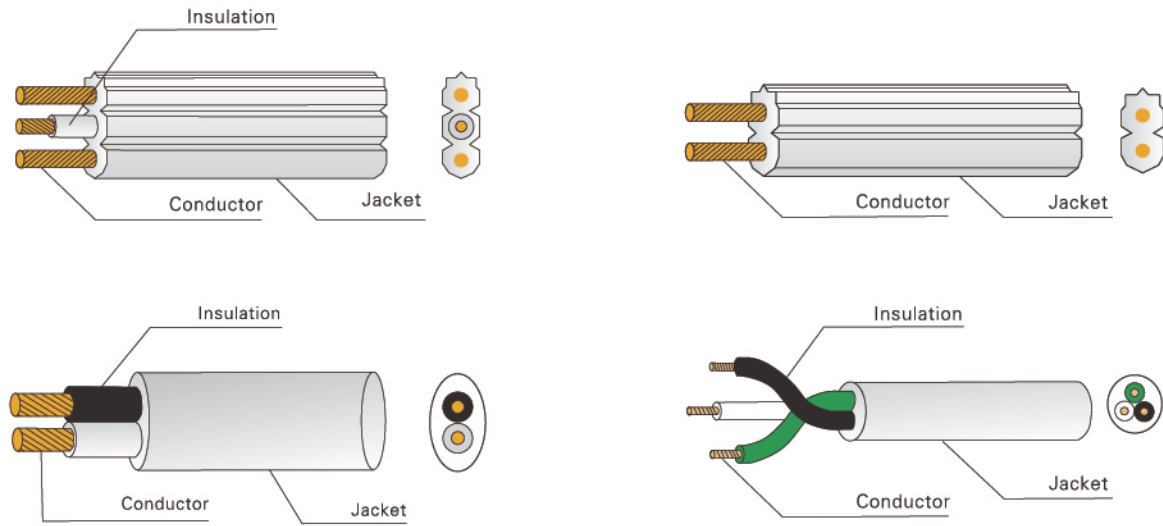

SPT-1, SPT-1W					
2	18	-	-	0.76	2.8×5.6
SPT-2, SPT-2W, SPT-2-R					
2	18	-	-	1.14	3.5×7.0
	16	-	-	1.14	3.8×7.4
3	18	0.38	2.0	1.14	3.5×9.0
	16	0.38	2.3	1.14	3.8×11.0
SPT-3					
2	18	-	-	1.52	4.4×8.7
	16	-	-	1.52	4.7×9.5
	14	-	-	2.03	6.0×12.0
3	18	0.38	2.0	1.52	4.4×10.8
	16	0.38	2.3	1.52	4.7×12.0
3	14	0.38	3.3	2.03	6.0×14.5
	NISPT-1				
2	18	0.38	2.0	0.38	2.6×4.8
NISPT-2					
2	18	0.76	2.8	0.38	3.7×6.8
	16		3.1		3.9×7.5
3	18	0.76	2.8	0.38	3.7×10.4
	16		3.1		3.9×11.0
SVT SVTO SVTOO					
2	18	0.38	2.1	0.76	5.8
	17		2.2		6.0
	16		2.3		6.4
3	18	0.38	2.1	0.76	6.1
	17		2.2		6.4
	16		2.3		6.8

UL
CUL
ETL
CETL

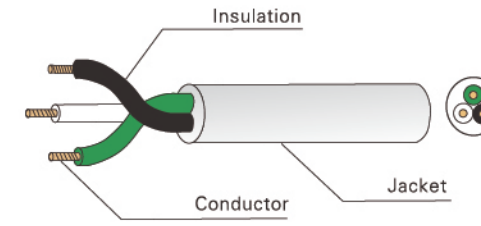

SJT, SJTW, SJTO, SJTOW, SJTOO, SJTOOW, SJT-R					
2	18	0.76	2.8	0.76	7.5
	16		3.1		8.1
	14		3.5		8.8
	12		4.0		10.8
3	18	0.76	2.8	0.76	7.9
	16		3.1		8.6
	14		3.5		9.4
4	18	0.76	2.8	0.76	8.6
	16		3.1		9.2
	14		3.5		10.3
5	18	0.76	2.8	0.76	9.4
	16		3.1		10.3
	14		3.5		11.4
5	12	0.76	4.0	1.14	13.6
	14		4.0		13.6
	12		4.0		13.6
ST, STW, STO, STOW, STOO, STOOO					
	18	0.76	2.8	1.52	8.9
	16		3.1		9.4
	14		4.3		12.9
	12		4.8		14.7
3	18	0.76	2.8	1.52	9.3
	16		3.1		9.9
	14		4.3		13.5
4	18	1.14	4.8	2.41	15.4
	16		4.8		15.4
	12		4.8		15.4
4	18	0.76	2.8	1.52	10.0
	16		3.1		10.7
	14		4.3		14.7
5	18	1.14	4.8	2.41	16.7
	16		4.8		16.7
	12		4.8		16.7
5	18	0.76	2.8	2.03	11.8
	16		3.1		12.6
	14		4.3		16.7
5	12	1.14	4.8	2.41	18.0
	14		4.8		18.0
	12		4.8		18.0
HPN, HPN-R					
2	18	-	-	1.14	3.5×7.0
	16	-	-	1.14	3.8×7.6
	14	-	-	1.52	6.5×11.7
3	18	0.38	2.0	1.14	3.7×9.0
	16	0.38	2.3	1.14	3.9×11.0
	14	0.38	3.3	1.52	6.5×13.9

UL
CUL
ETL
CETL

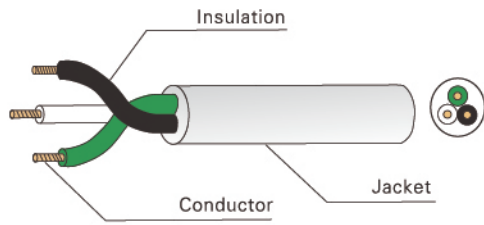

SV, SVO, SVOO					
2	18	0.38	2.1	0.76	5.8
	17		2.2		6.0
	16		2.3		6.4
3	18	0.38	2.1	0.76	6.1
	17		2.2		6.4
	16		2.3		6.8
SJ, SJO, SJOW, SJO, SJOOW					
2	18	0.76	2.8	0.76	7.5
	16		3.1		8.1
	14		3.5		8.8
	12		4.0		1.14
3	18	0.76	2.8	0.76	7.9
	16		3.1		8.6
	14		3.5		9.4
	12		4.0		1.14
4	18	0.76	2.8	0.76	8.6
	16		3.1		9.2
	14		3.5		10.3
	12		4.0		1.14
5	18	0.76	2.8	0.76	9.4
	16		3.1		10.3
	14		3.5		11.4
	12		4.0		1.14
S, SO, SOW, SOO, SOOW					
2	18	0.76	2.8	1.52	8.9
	16		3.1		9.4
	14	1.14	4.3	2.03	12.9
			12		4.8
3	18	0.76	2.8	1.52	9.3
	16		3.1		9.9
	14	1.14	4.3	2.03	13.5
			12		4.8
4	18	0.76	2.8	1.52	10.0
	16		3.1		10.7
	14	1.14	4.3	2.03	14.7
			12		4.8
5	18	0.76	2.8	2.03	11.8
	16		3.1		12.6
	14	1.14	4.3	2.41	16.7
			12		4.8

UL
CUL

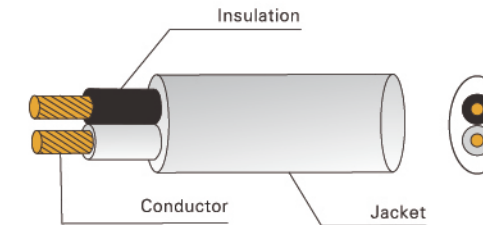

HHFF						
No.	Conductor		Insulation (mm)		Max conductor resistance at 20°C Ω/KM	
	Area	Thickness	OD	Bare	Tinned	
2	0.75	1.0	3.2×6.4	24.4	25.8	
	1.25		3.6×7.2	14.7	15.5	
	2.0		3.9×7.8	9.5	9.91	
PNCTFK						
2	0.75	0.6	2.3	1.0	4.4×6.8	
	1.25		2.7		4.8×7.6	
	2.0		3.0		5.1×8.2	
PNCTF						
2	0.75	0.6	2.4	1.0	6.8	
	1.25		2.7		7.8	
	2.0		3.1		8.4	
3	0.75	0.6	2.4	1.0	7.2	
	1.25		2.7		8.3	
	2.0		3.1		9.1	
4	0.75	0.6	2.4	1.1	8.0	
	1.25		2.7		9.2	
	2.0		3.1		9.9	
2PNCT 2PHCT						
2	0.75	0.8	2.8	1.7	9.0	
	1.25		3.1		9.8	
	2.0		3.5		11.0	
3	0.75	0.8	2.8	1.7	9.4	
	1.25		3.1		10.5	
	2.0		3.5		11.5	
4	0.75	0.8	2.8	1.8	10.5	
	1.25		3.1		11.5	
	2.0		3.5		12.5	

PSE

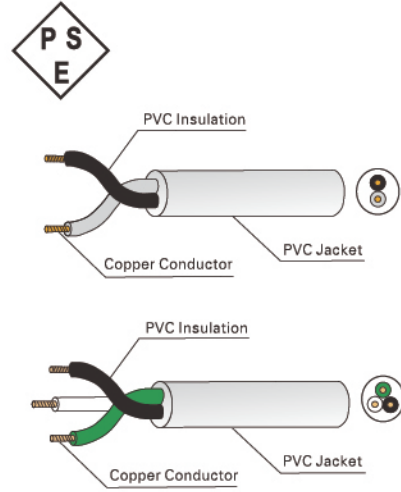

VCTF/HVCTF PVC FLEXIBLE CORD

No. of Core	Conductor		Insulation		Jacket		Amp. Rating
	Sectional Area(mm ²)	Construction (No./mm)	Nom.Thick (mm)	Nom.Dia (mm)	Nom.Thick (mm)	Nom.Dia (mm)	
2	0.75	30/0.18	0.60	2.40	1.00	6.7	7A
	1.25	50/0.18		2.75		7.5	12A
	2.00	37/0.28		3.15		8.1	15A
3	0.75	30/0.18	0.60	2.40	1.00	7.1	7A
	1.25	50/0.18		2.75		7.9	12A
	2.00	37/0.28		3.15		8.6	15A
4	0.75	30/0.18	0.60	2.40	1.00	7.7	7A
	1.25	50/0.18		2.75		8.6	12A
	2.00	37/0.28		3.15		9.4	15A

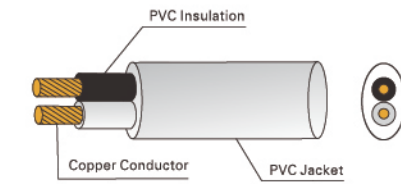

VCTFK/HVCTFK PVC FLEXIBLE CORD

No. of Core	Conductor		Insulation		Jacket		Amp. Rating
	Sectional Area(mm ²)	Construction (No./mm)	Nom.Thick (mm)	Nom.Dia (mm)	Nom.Thick (mm)	Nom.Dia (mm)	
2	0.75	30/0.18	0.60	2.40	1.0	4.4X6.6	7A
	1.25	50/0.18		2.75		4.7X7.4	12A
	2.00	37/0.28		3.15		5.1X8.0	15A

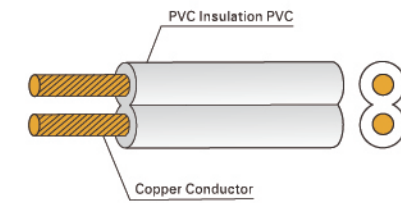

VFF/HVFF PVC FLEXIBLE CORD

No. of Core	Conductor		Insulation		Amp. Rating
	Sectional Area(mm ²)	Construction (No./mm)	Nom.Thick (mm)	Nom.Dia (mm)	
2	0.50	20/0.18	0.80	2.6X5.2	3A
	0.75	30/0.18		2.8X5.6	7A
	1.25	50/0.18		3.2X6.4	12A
	2.00	37/0.28		3.4X6.8	15A

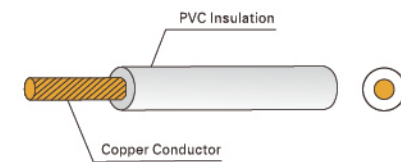

VSF/HVSF PVC FLEXIBLE CORD

No. of Core	Conductor		Insulation		Amp. Rating
	Sectional Area(mm ²)	Construction (No./mm)	Nom.Thick (mm)	Nom.Dia (mm)	
1	0.50	20/0.18	0.80	2.5	3A
	0.75	30/0.18		2.7	7A
	1.25	50/0.18		3.1	12A
	2.00	37/0.28		3.4	15A

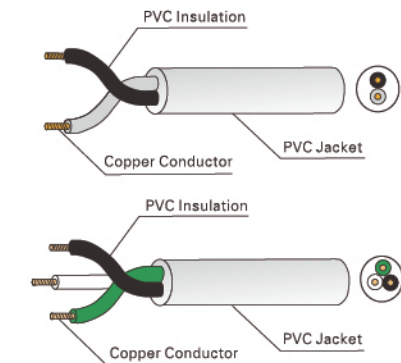

VCT/HVCT PVC FLEXIBLE CORD

No. of Core	Conductor		Insulation		Jacket		Amp. Rating
	Sectional Area(mm ²)	Construction (No./mm)	Nom.Thick (mm)	Nom.Dia (mm)	Nom.Thick (mm)	Nom.Dia (mm)	
2	0.75	30/0.18	0.80	2.75	1.7	8.80	7A
	1.25	50/0.18		3.10		9.60	12A
	2.00	37/0.28		3.60		10.5	15A
3	0.75	30/0.18	0.80	2.75	1.7	9.20	7A
	1.25	50/0.18		3.10		10.5	12A
	2.00	37/0.28		3.60		11.0	15A

国际电缆资料

WORLDWIDE CABLE AND WIRE INFORMATION

● 一般电线电缆截面的标注主要有以下三种方法:

- 1. 北美的AWG系统 如:18AWG
- 2 协调系统的XXmm² 如:0.75mm²(18AWG=0.823mm²)
- 3 IEC227的XXmm² 如:0.75mm²(18AWG=0.823mm²)

● Generally, there are three main cordage type used in the world:

- 1.The American wire Gauge (AWG) system used in North America.
- 2.The European Harmonized types.In AWG system, the cordage is described in terms of wire gauge size such as18AWG,while (an 18AWG conductor is comparable to 0.823mm²)
- 3.IEC types Xxmm²

● 电线内部导线的构成:

	北美	协调系统	IEC227
L=火线	黑色	棕色	棕色
N=中线	白色	蓝色	蓝色
E=地线	绿色	黄/绿色	黄/绿色

● CONDUCTOR COLOUR CODES:

	North America	Harmonized	IEC227
L=Live	Black	Brown	Brown
N=Neutral	White	Blue	Blue
E=Earth	Green	Green/Yellow	Green/Yellow

● 协调系统电线规格说明:

如例举:H05VVH₂-F 2X0.75mm²

Harmonized wire coding system:

This chart illustrates the harmonization:H05VVH₂-F 2X0.75mm²

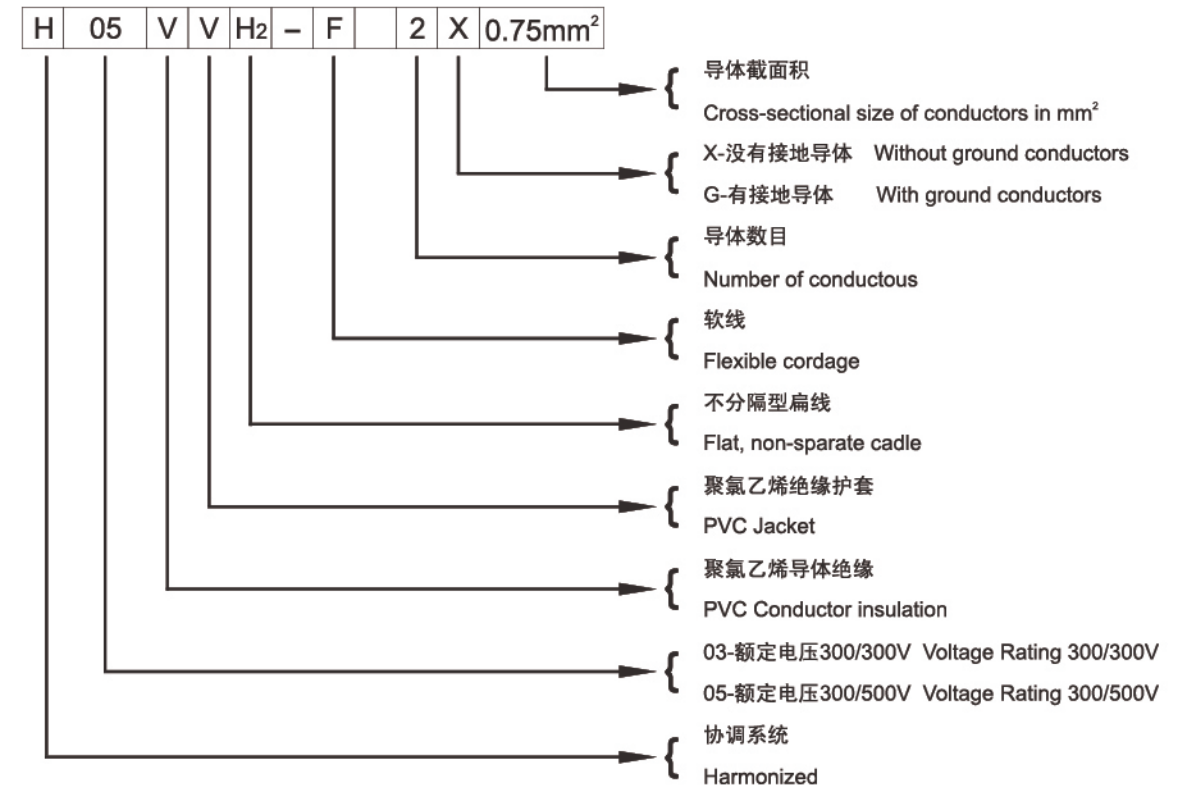

国际插头资料 WORLDWIDE PLUG INFORMATION

● 国际插头概况简图:
The world Plug drawing:

代号 Configuration Code	A	B	C	D	E
简图 Configuration Diagram					
主要采用国家 Type of power Supply	中国 美国 日本 China U.S.A Japan	美国 U.S.A	欧共体 Europe	欧共体 Europe	欧共体 Europe

代号 Configuration Code	F	G	H	I	J
简图 Configuration Diagram					
主要采用国家 Type of power Supply	丹麦 Denmark	瑞士 Switzerland	意大利 Italy	英国 Britain	英国 Britain

代号 Configuration Code	K	L	M		
简图 Configuration Diagram					
主要采用国家 Type of power Supply	澳大利亚 Australia	澳大利亚 Australia	以色列 Israel		

上述简图列出了全世界的电源线插头一个概况, 所列图形是关于工业国家电气系统的标准图形是非常精确可靠的。

This chart presents an overview of power supply systems throughout the world, The configurations listed for the electrical systems of industrialized countries are accurate and reliable.

标准 STANDARD	认证机构(英文) APPROVAL(English)	标记 MARK	国家 COUNTRY	认证机构(中文) APPROVAL(Chinese)
CCEE	China commission for conformity certification of electrical equipment.		中国 CHINA	中国电工产品认证委员会
VDE	Verband Deutscher Elektrotechniker V.Prufstelle.		德国 Germany	德国电气技术者协会
KEMA	Naamloze Vennootschap tot Keuring Van Ele krtotechnische Materialen		荷兰 Holand	荷兰电气标准
SEV	Schweizerischen Elektrotechnischen Vercins		瑞士 Switzerland	瑞士电器标准
SEMKO	Svenska Elektriska Materielkontrollanstalten		瑞典 Sweden	瑞典电器标准
NEMKO	Norges Elektriske Materielkontroll		挪威 Norway	挪威电气机器试验所
DEMKO	Danmarks Elektriske Materielkontroll		丹麦 Danmark	丹麦电气机器试验所
FI	Suomen Standardisoimislutto		芬兰 Finland	芬兰电气机械标准
OVE	Osterreichischer Verband fur Elektrotechnik		奥地利 Austria	奥地利电气机械标准
CEBEC	Norme Belge		比利时 Belgium	比利时电气用品标准
IMQ	Istituto Italiano del Marchio di Qualita		意大利 Italy	意大利家电机具试验所
NF	Normes Francaises		法国 France	法国国家标准
UL	Underwriters Laboratories, Inc		美国 America	美国保险协会实验室
C-UL	Canadian Standard Association		加拿大 Canada	加拿大标准协会
SII	Israel Standard Association		以色列 Israel	以色列标准协会
SAA	The Standards Association of Australia		澳大利亚 Australia	澳洲国家标准协会
BSI	BSI Product Certification		英国 English	英国标准协会
T-MARK	One of Japanese Standard symbol Mark		日本 Japan	日本电器标准
KS	CERTIFICATE OF COMPLIANCE		韩国 Korea	CERTIFICATE OF COMPLIANCE
ITS-GS	Intertek Testing Services ETL SEMKO		ITS GS	Intertek Testing Services ETL SEMKO
BSA	BRAZIL STANDARD ASSOCIATION		巴西 Brazil	BRAZIL STANDARD ASSOCIATION
IRAM	INSTITUTO ARGENTINO DE NORMALIZACION		阿根廷 Argentina	INSTITUTO ARGENTINO DE NORMALIZACION

JUN 云锦电器

余姚市云锦电器有限公司
Yuyao Yunjin Electrical Appliance Co., Ltd



电话(Tel): 0574-62160980
手机(Mob): 18072038796
传真(Fax): 0574-62100790
邮箱(E-mail): 1390204519@qq.com
网址(Web): www.yyyunjin.com
地址: 中国浙江余姚市泗门镇共济路5号
Address: No.5 Gongji Road, Simen Town, Yuyao Zhejiang, 315470

JUN

云锦电器

YUNJIN ELECTRICAL

智能灯串

smart string lights

余姚市云锦电器有限公司
Yuyao Yunjin Electrical Appliance Co., Ltd

